



LevelOne

FCS-5030

IP Network Camera w/ Infrared LEDs

User Manual

Ver 1.2.0 – 0904

Before You Use This Product

The use of surveillance devices may be prohibited by law in your country. The Network Camera is not only a high-performance web-ready camera but also can be part of a flexible surveillance system. It is the user's responsibility to ensure that the operation of such devices is legal before installing this unit for its intended use.

It is important to first verify that all contents received are complete according to the list in the "Package Contents" chapter. Take notice of the warnings before the Network Camera is installed, then carefully read and follow the instructions in the "Installation" chapter to avoid damages due to faulty assembly and installation. This also ensures the product is used properly as intended.

The Network Camera is a network device and its use should be straightforward for those who have basic network knowledge. The "Troubleshooting" chapter in the Appendix provides remedies to the most common errors in set up and configuration. You should consult this chapter first if you run into a system error.

The Network Camera is designed for various applications including video sharing, general security/surveillance, etc. The "How to Use" chapter suggests ways to best utilize the Network Camera and ensure proper operations. For the creative and professional developers, the "URL Commands of The Network Camera" chapter serves to be a helpful reference to customize existing homepages or integrating with the current web server.

For paragraphs preceded by  the reader should use caution to understand completely the warnings. Ignoring the warnings may result in serious hazards or injuries.

Table of Contents

Package Content.....	5
Installation.....	6
Hardware installation.....	6
Software installation.....	8
How to Use Installation Wizard.....	9
Using Installation Wizard.....	12
Initial Access to the Network Camera.....	29
Check Network Settings.....	29
Add Password to prevent Unauthorized Access.....	29
How to Use.....	29
Authentication.....	30
Installing plug-in.....	31
Primary user's capability.....	32
Main Screen with Camera View.....	32
Digital Zoom.....	34
MP4 Recording.....	35
Snapshot.....	35
Local Settings.....	36
Digital output.....	38
Administrator's capability.....	39
Fine-tuning for Best Performance.....	39
Opening accounts for new use.....	41
Build a security application.....	42
Software revision upgrade.....	43
Definitions in Configuration.....	44
Basic-Network.....	44
Network type.....	44
Audio and Video.....	46
Video Settings.....	46
Audio settings.....	47
Image Settings.....	48
Privacy Mask.....	50
System.....	52
User Management.....	53
Advanced-Network.....	54
DDNS.....	55

HTTP.....	55
Two way audio.....	56
FTP.....	56
RTSP Streaming	56
IP Filtering	58
Motion detection	59
Event Setup	60
Event.....	61
Server.....	62
Media Setting	64
Recording.....	66
Peripherals	68
System log.....	69
Maintenance.....	70
Appendix	71
A. Troubleshooting	71
Reset and restore	71
B. URL commands of the Network Camera	93
Overview	93
Style convention.....	93
General CGI URL syntax and parameters.....	94
Security level	94
Get server parameter values	94
Set server parameter values	96
Available parameters on the server	97
Drive the digital output.....	117
Query status of the digital input.....	118
Query status of the digital output	119
Capture single snapshot	120
Account management	120
System logs.....	121
Upgrade firmware	122
IP filtering.....	122
RTSP SDP	123
D. Specifications	125

Package Content

1. FCS-5030
2. Power Adapter
3. Camera Stand
4. CD Manual/Utility
5. Quick Installation Guide

Installation

In this manual, "User" refers to whoever has access to the Network Camera, and "Administrator" refers to the person who can configure the Network Camera and grant user access to the camera.

Hardware installation



Please verify that your product package contains all the accessories listed in the foregoing Package Contents. Depending on the user's application, an Ethernet cable may be needed. The Ethernet cable should meet the specs of UTP Category 5 and not exceed 100 meters in length.

To install in Ethernet

Make sure the Ethernet is firmly connected to a switch hub. After attaching the Ethernet cable plug in the power adapter. If the LED turns out to blink orange-color, go to next paragraph "Software installation".

This Network Camera provides a general I/O terminal block with one digital input and one digital output device control. The pin definition is as below.

 Consult with the dealer of the peripherals for correct installation.

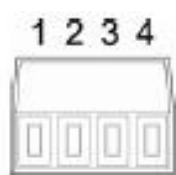

- | | | |
|---|-----------|--|
| 1 | SW_NOPEN | OUTPUT (Max. 400mA, 12VDC \pm 5%) |
| 2 | SW_COMMON | OUTPUT (open from SW_OPEN at initial state) (close with SW_OPEN when set DO to ON) |
| 3 | DI+ | INPUT (Max. 50mA, 12VDC) |
| 4 | DI- | INPUT (Initial state of DI is low) |

Make connections

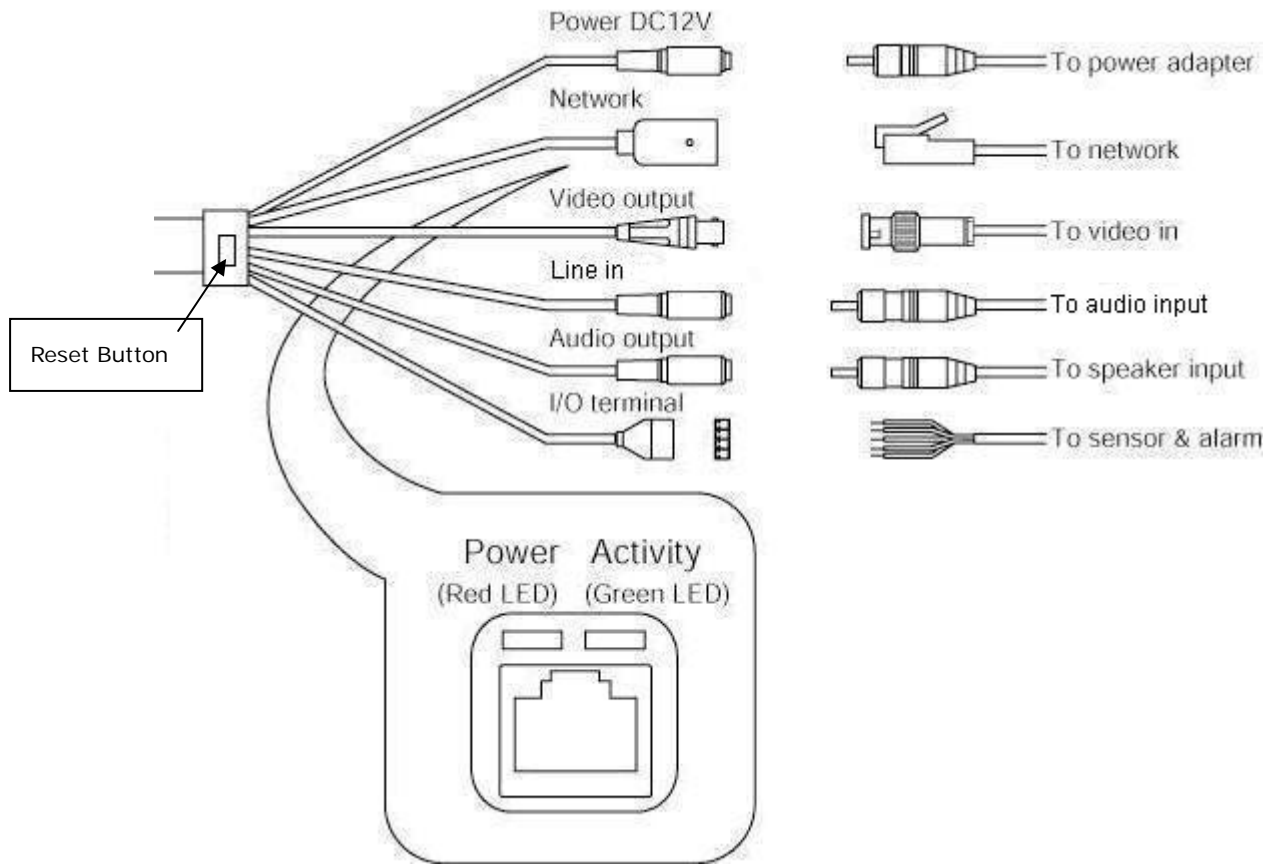

Waterproof Process

To completely avoid the camera from water sock, apply waterproof process if necessary.

Utilize silicone clay or similar waterproof material applied to the screws, screw holes and other necessary portions.

Tape the junction points of the connectors on the cable.

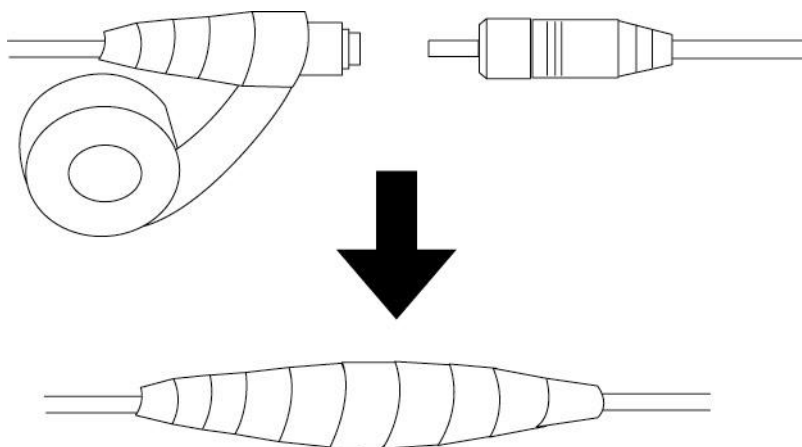

Software installation

At the end of the hardware installation, users can use Installation Wizard program included in the product CDROM to find the location of the Network Camera. There may be many Network Cameras in the local network. Users can differentiate the Network Cameras with the MAC address . **The MAC address is printed on the label which is on the bottom of the Network Camera body.** Please refer to the Quick installation guide of Installation Wizard for details.

Once installation is complete, the Administrator should proceed to the next section "Initial Access to the Network Camera" for necessary checks and configurations.

How to Use Installation Wizard

Installation

The following are steps for the software installation.

STEP 1: Put the Installation disk into the CD-ROM drive, and the installation should start automatically. If the installation does not start, click on “Start” on the lower left corner of your screen, open “My Computer” and double click on the CD-ROM->Installation_Wizard.exe. The Installation Wizard Installation Window will appear.

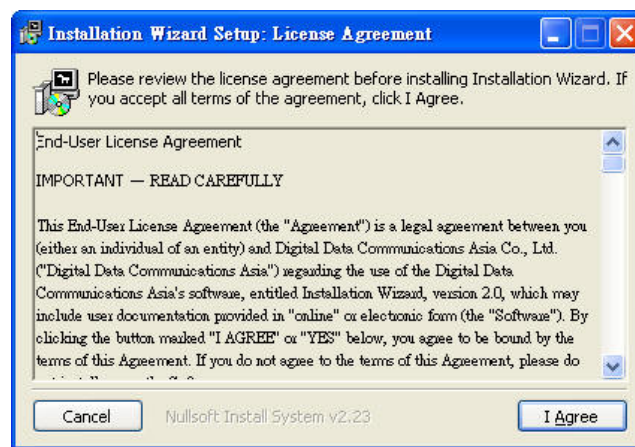

Installation Wizard Installation Window

STEP 2: Please read the license agreement first, and then click on “I Agree” to continue the installation process. The install process will go on and then the below window will appear. This page is for you to select the additional component you want to install. The component “Create shortcut on desktop” will create a shortcut on the desktop. It is more convenient for you to launch Install Wizard 2. After selecting the components, please click on the “Next” Button to continue.

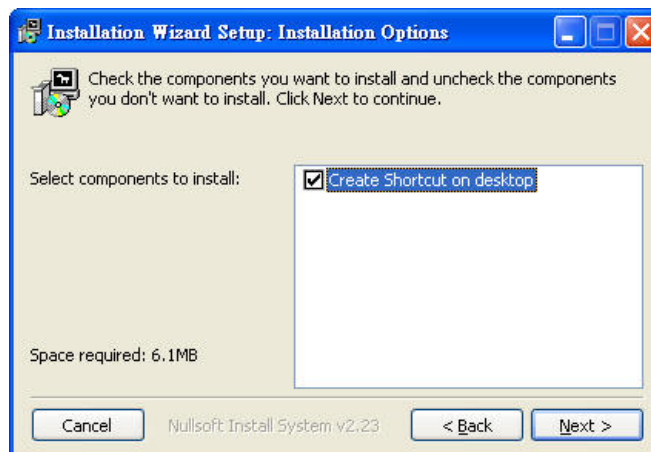

Select components to install for the Installation Wizard

STEP 3: Select the installation directory for this application software and click on “Install” button. You can also change the installation directory by clicking on “Browse...” button. After the proper directory chose, please click on the “Install” button to continue.

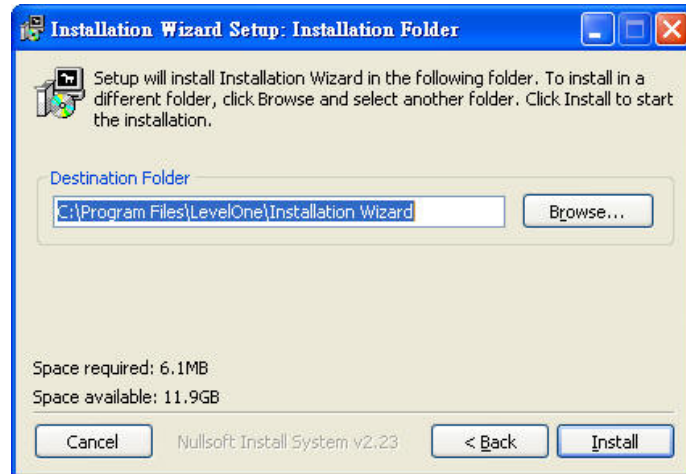

Destination Location for Installation

STEP 4: After clicking “Install” button, the install system will install the Installation Wizard to your computer, and a progress bar will display on the dialog. After completed the installation, please click on the “Close” button.

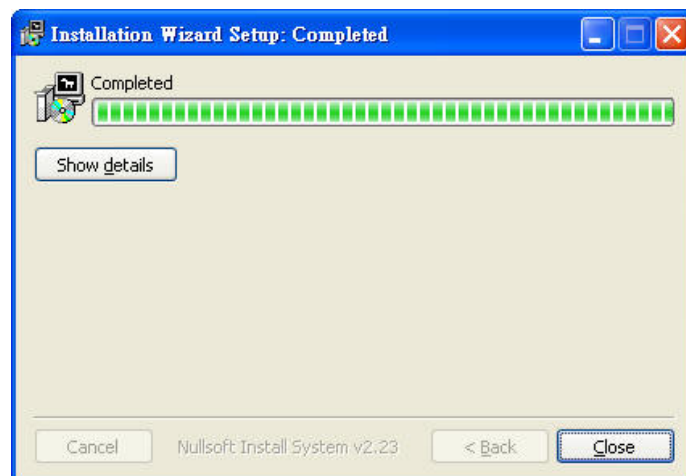

Completed

Using Installation Wizard

User Interface

Once you run the Installation Wizard, after a short searching time, you will see the user interface as below. “**Manual Setup**” button, a “**Refresh Devices**” button and an arrow button on the left panel of your user interface. When you click on the arrow button, you will see more advanced functional buttons: “**Firmware Upgrade**”, “**Restore Default**” and “**About IW**”. You can select your device by double-clicking it in the device list. The left three buttons (“**Manual Setup**”, “**Firmware Upgrade**”, and “**Restore Default**”) won’t be enabled until you select at least one device.



User interface of Installation Wizard

Installation Wizard allows you to setup one device at one time and upgrade multiple devices (of the same model) at the same time. If you selected different models, then the “**Firmware Upgrade**” button would be disabled.

Installation Wizard

Installation Wizard

Device Selection
Select a device to setup or upgrade



MAC	IP Address	Model
00-11-6B-80-8B-0C	192.168.50.156	FCS-3021

Manual Setup

Refresh Devices

⏪

Firmware Upgrade

Restore Default

About IW

Please check the MAC and model name in the product label of your device first. Then, you can start to link to your device and show the main screen by double clicking the item in the above selection list.

If you are not able to find your device in the above selection list, please make sure all cables are properly connected to your device and then click on the "Refresh Devices" button.



You can find the product label in the rear/bottom part of your device.

User interface of Installation Wizard after clicking on the arrow button

Action buttons

Installation Wizard

Device Selection
Select a device to setup or upgrade

level one

Manual Setup

Refresh Devices

⬆

Firmware Upgrade

Restore Default

About IW

MAC	IP Address	Model
00-11-6B-80-8B-0C	192.168.50.156	FCS-3021

Please check the MAC and model name in the product label of your device first. Then, you can start to link to your device and show the main screen by double clicking the item in the above selection list.

If you are not able to find your device in the above selection list, please make sure all cables are properly connected to your device and then click on the "Refresh Devices" button.

Model No: FCS-3021
00116B8XXXXX
MAC: 00116B8XXXXX
HW Ver: 1.0
CE FC
You can find the product label in the rear/bottom part of your device.

Refresh devices

Clicking on the **"Refresh Devices"** button will refresh the device list and search all devices on the LAN again. Refreshing the device list will take several seconds.

If you want to link to your device, double-clicking it on your device list will lead you to the browser for operating your device.

Function buttons

MAC	IP Address	Model
00-11-6B-80-8B-0C	192.168.50.156	FCS-3021

Function buttons

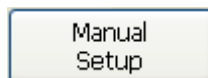

Click on this button to modify the setting of the selected devices. For more detail, please refer to 0 Manual Setup.



Click on this button to upgrade the firmware of the selected devices. For more detail, please refer to 0 Upgrade

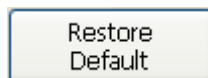

Click on this button to restore the selected device to factory default.



Click on this button to get version information of the Installation Wizard .

Manual Setup

When you select one device in the selection list, the “**Manual Setup**” button will be enabled. Click on it to modify the settings of the selected device. After clicked on the “**Manual Setup**” button, Installation Wizard would try to connect to the selected device.

The default Administrator’s password is blank and the Network Camera initially will not ask for any password. If the authentication is failed, there would be a pop-up dialog window to ask for correct password. If you failed three times, the Installation Wizard would show you a warning dialog window and abort the connecting to the selected device.

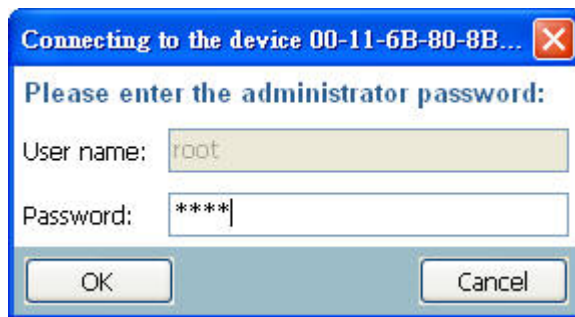

Authentication Dialog Window

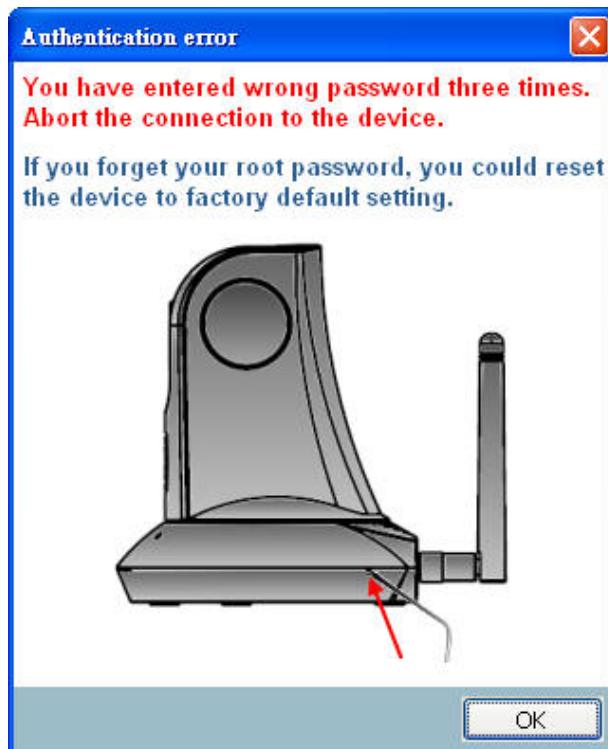

Authentication error

System Setting

After connected to the selected device, the Installation Wizard will switch to system setting page as below.

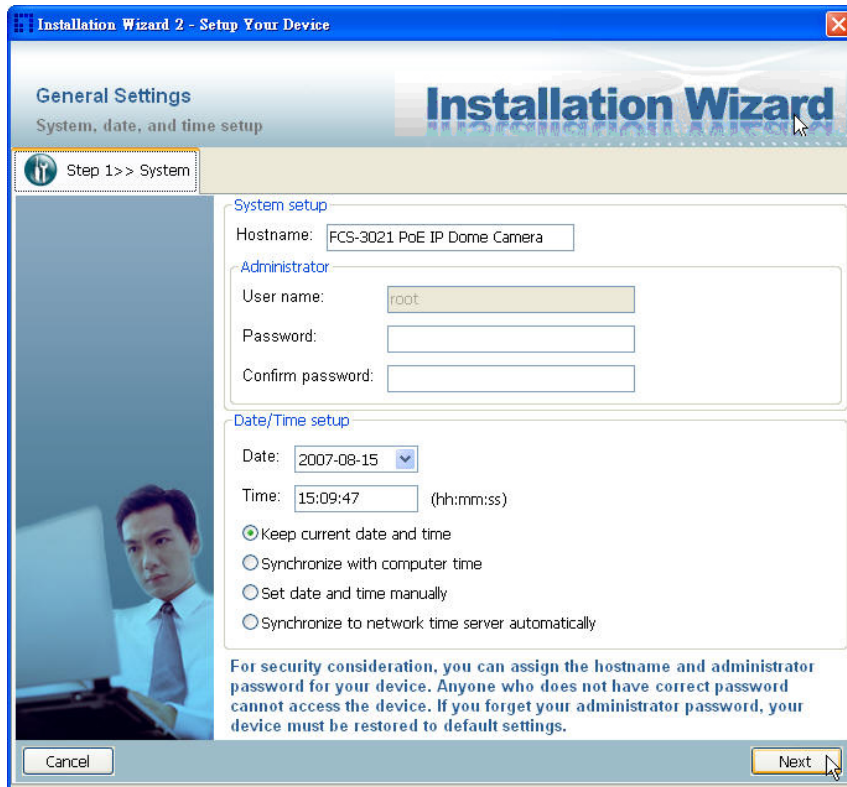

System setting page

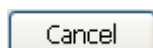

Click on this button to cancel the setup progress.

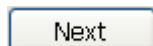

Click on this button to keep the present setting and go to the next page.

Change Host Name

The “**Hostname**” is used for the homepage title of main page and is displayed as the title in the video window of the main page. The maximum string length is 40 characters or 20 characters in double-byte-character-systems like Chinese or Japanese. But for some models supported Unicode, the maximum string length depends on the characters you input, and it may less than 20 characters.

Change root password

To change the administrator’s password, type the new password in both “**Password**” and “**Confirm Password**” text boxes identically. What is typed will be displayed as

asterisks for security purposes. The maximum password depends on the server you connected.

Adjust date and time

Date/Time setup

Date: ▼

Time: (hh:mm:ss)

Keep current date and time

Synchronize with computer time

Set date and time manually

Synchronize to network time server automatically

Date/Time setup

There are three ways to adjust system date and time:

1. **"Synchronize with computer time"**: The easiest way is to make device synchronized with your computer time.
2. **"Set date and time manually"**: Set the date and time manually by entering new values. Notice the format in the related field while typing.
3. **"Synchronize to network time server automatically"**: Make device automatically synchronize with timeservers over the Internet every hour.

If you want to keep the current date and time, please choose **"Keep current date and time"**.

Network Setting

The Installation Wizard can help you to setup the network connection with LAN or PPPoE. After you clicked on the “**Next**” button on the System page, the Installation Wizard would lead you to the PPPoE setting page. If you want to connect your server to Internet via PPPoE, please click on “**Yes**” to start the PPPoE setting process, or click on “**No**” to invoke the LAN setting.

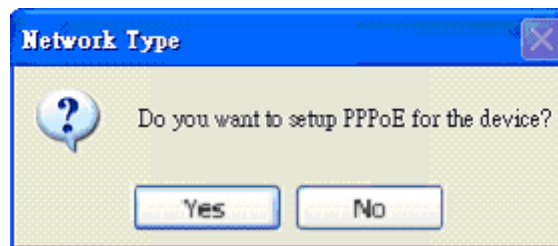

Choosing the network type

PPPoE Setting

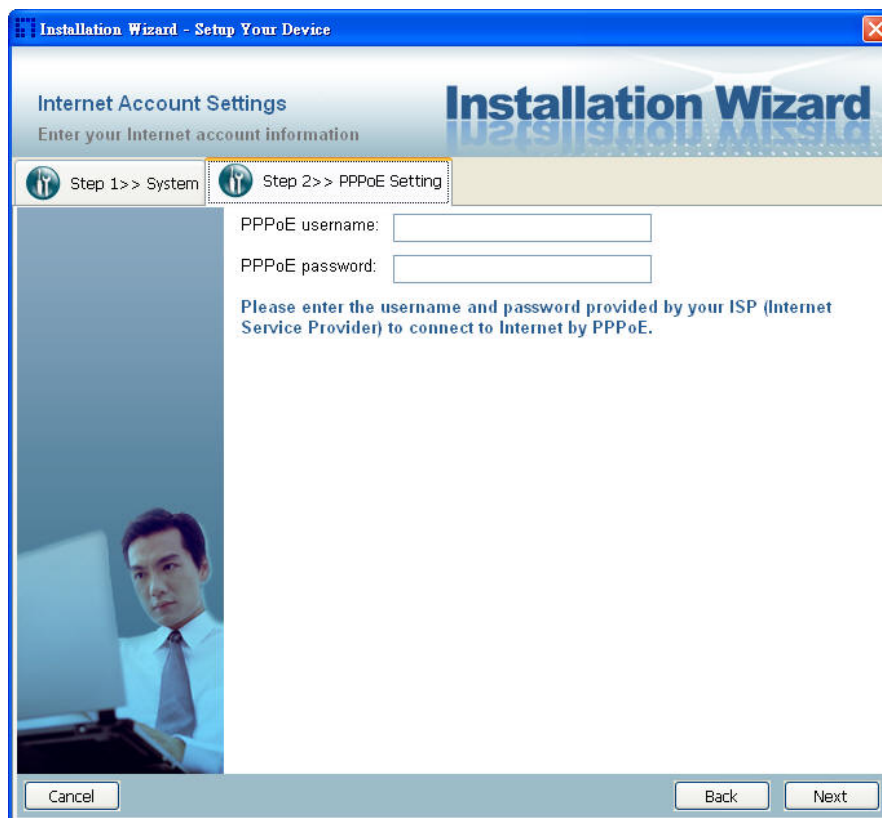

Network setting for PPPoE

If you click on “**Yes**” in the “Network Type” dialog window, you will be led to the PPPoE setting page. In this page, you can input the “**PPPoE username**” and

“PPPoE password” provided by your ISP, and then the server will be set to PPPoE mode rather than LAN mode when the setup is completed. If you don’t know the account information, please contact your ISP. After inputting the account information, please click on the **“Next”** button to continue your next step.

LAN Setting

If you click on “**No**” in the “Network Type” dialog window, you will be led to the Network setting page. In this page, you can change the server’s IP address, subnet mask, default gateway, primary DNS server, secondary DNS and DHCP server. Please refer to the below page.

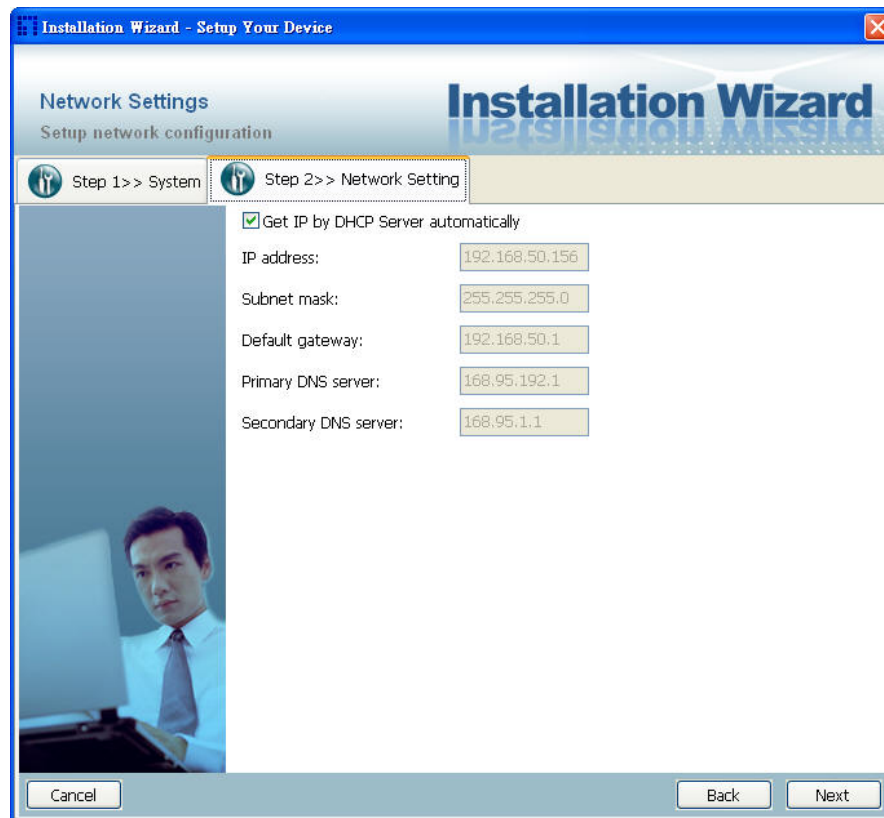

Network Setting for LAN

You could set up the network with DHCP or fixed IP:

1. DHCP: Check the "**Get IP by DHCP Server automatically**" will force the device to renew its IP address whenever it reboots, and the related network configuration is provided by the DHCP server.
2. Fixed IP: If you want the device to use a fixed IP, please uncheck the "**Get IP by DHCP Server automatically**" checkbox and assign a valid IP address, subnet mask, default gateway and DNS server for the device.

Mobile Access

After finished the DDNS setting and click on the Next button. If your device supports mobile viewer and you want to access the device by mobile phone, you can enable the “Mobile Access” by clicking on the Yes button. The Installation Wizard will do some setting for mobile viewing toward the device:

1. Video: The video codec will be set to MPEG-4, and the resolution will be set to 176x144 pixels.
2. Audio: The audio codec will be set to AAC.

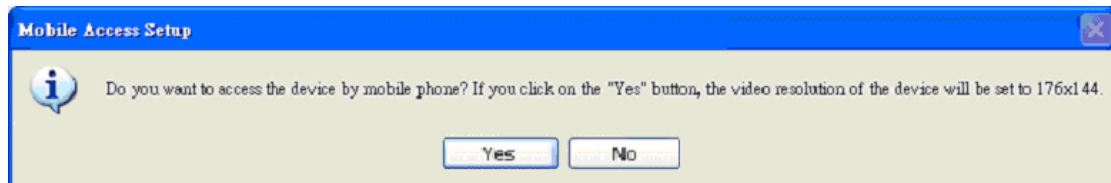

Mobile Access

Apply to selected device

After configuring all the settings, the apply page will show up. Click on “**Apply**” button to apply the changes to the selected device or click on “**Back**” button to go back to the previous page and modify the setting again.

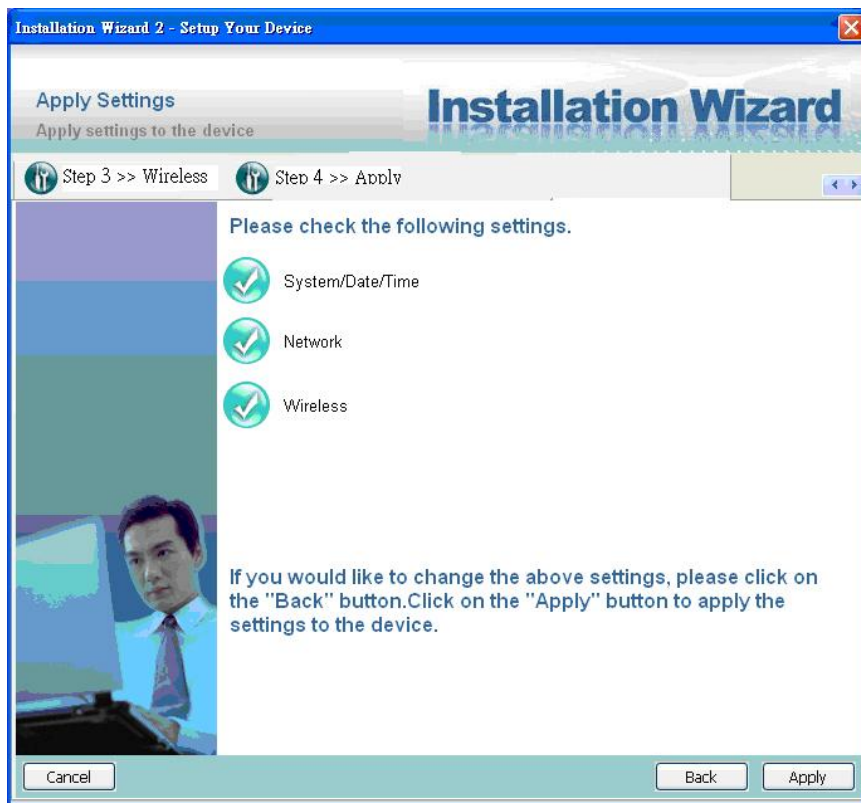

Apply page

When you click on the “Apply”, it will start to update your settings to server.

Upgrade

When you select one device or multiple devices (of the same model), the **“Firmware Upgrade”** button will be enabled. Click on it to upgrade the firmware of the selected device(s). After click on the **“Firmware Upgrade”** button, Installation Wizard will try to connect the selected device(s) and lead you to the firmware upgrade page.

Click on the “Firmware Upgrade”

Device Information

After connected to the selected device(s), it would display as below. If you select more than one device, then the device information will show all the selected devices. You can switch to the server info by click on the tab control.

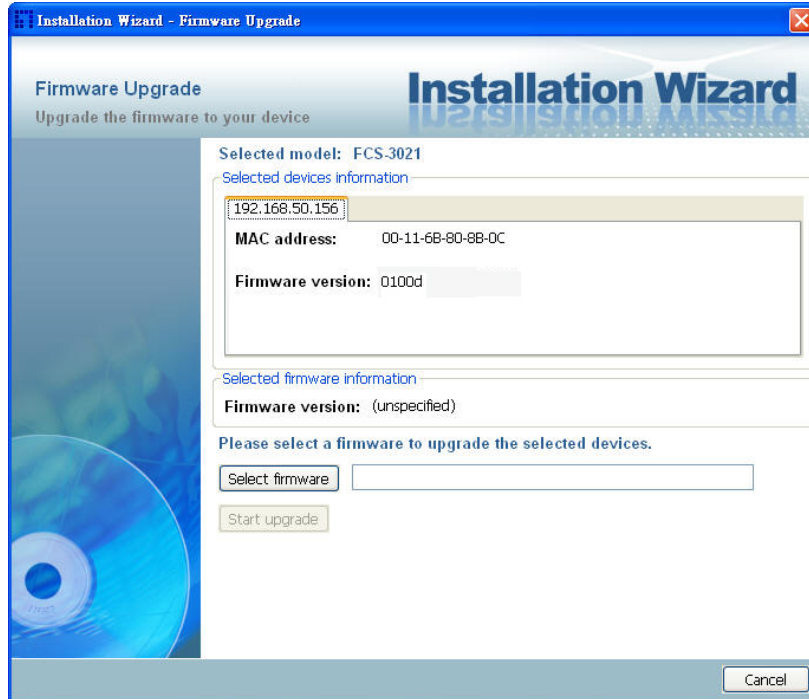

Device information

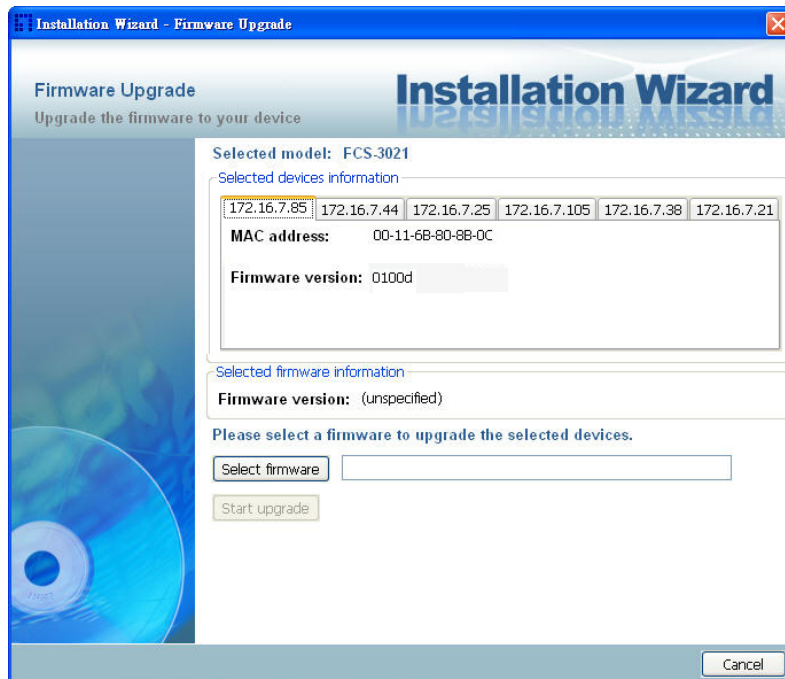

Multiple devices information

Firmware Information

The selected firmware information will show the information about the file that you selected.

- **Firmware version:** The version number of the selected firmware.

Select Firmware

You can use the “**Select firmware**” button to browse the file that you want upgrade onto the selected device(s). After selected the file, Installation Wizard will check whether the file you selected is correct. If it's the correct version, then the package information will display the information about the file and enable the “**Start Upgrade**” button. Therefore you can click on the button to upgrade the firmware. If not, then it will be a pop-up warning message.

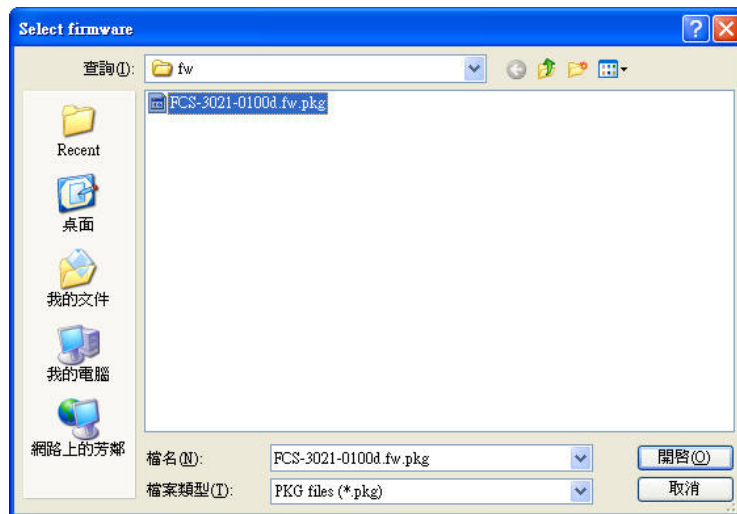

Select firmware

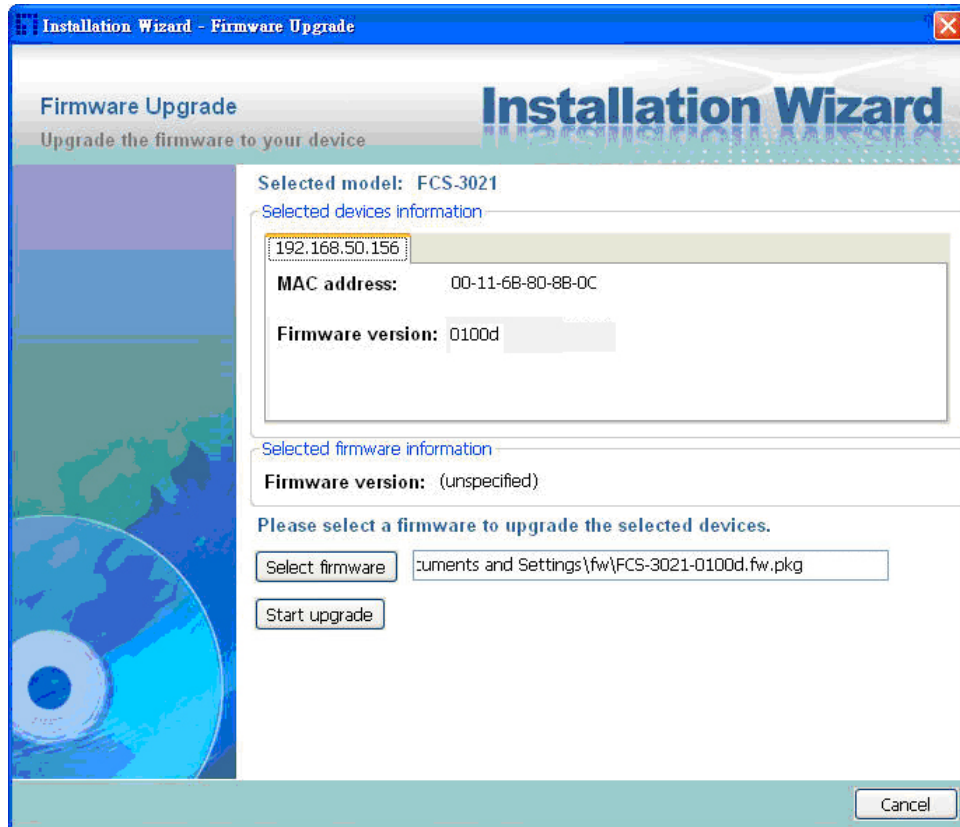

Firmware Information

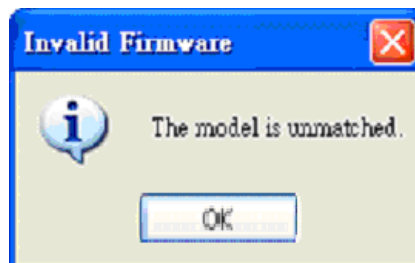

Warning message for unmatched firmware

Start Upgrade

Clicking on the “**Start Upgrade**” button to upgrade the firmware of the selected device(s), and it will be a pop-up dialog window to show the progress of the upgrading process. Usually, it will take about 5 to 10 minutes to finish the firmware upgrading. It depends on your server model and network bandwidth. We recommend you do the upgrade process in wired LAN environment rather than PPPoE or wireless environment.

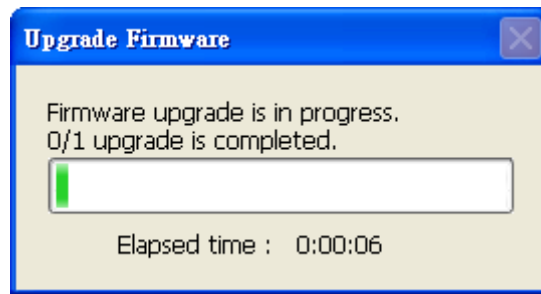

Update progress

After the upgrade process had been done, you could see the dialog window as below. Please click on the button "OK" to finish it.

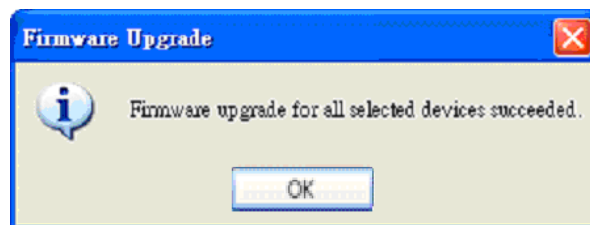

Upgrade Done

Initial Access to the Network Camera

Check Network Settings

The Network Camera can be connected either before or immediately after software installation onto the Local Area Network. The Administrator should complete the network settings on the configuration page, including the correct subnet mask and IP address of gateway and DNS. Ask your network administrator or Internet service provider for the detail information. By default the Network Camera requires the Administrator to run installation every time it reboots. If the network settings are to remain unchanged, disable the Install option. Refer to “Network settings” on the System Configuration page for details. If any setting is entered incorrectly and cannot proceed to setting up the Network Camera, restore the factory settings following the steps in the “Troubleshooting” chapter of the Appendix.

Add Password to prevent Unauthorized Access

The default Administrator’s password is blank and the Network Camera initially will not ask for any password. **The Administrator should immediately implement a new password as a matter of prudent security practice.** Once the Administrator’s password is saved, the Network Camera will ask for the user’s name and password before each access. The Administrator can set up a maximum of twenty (20) user accounts. Each user can access the Network Camera except to perform system configuration. Some critical functions are exclusive for the Administrator, such as system configuration, user administration, and software upgrades. The user name for the Administrator is permanently assigned as “root”. Once the password is changed, the browser will display an authentication window to ask for the new password. **Once the password is set, there is no provision to recover the Administrator’s password. The only option is to restore to the original factory default settings.**

How to Use

A PC with Windows operating system can use the Internet Explorer to connect to the Network Camera. A plug-in will be installed into the IE when it is connected for the first time. A PC with Linux operating system can connect to the camera using a browser like Firefox. It needs to install QuickTime first to view streaming.

Authentication

After opening the Web browser and typing in the URL of the Network Camera, a dialogue window pops up to request a username and password. Upon successful authentication, the following figure is displayed.

The foreground is the login window and the background shows the message if authentication fails. The user may check the option box to save the password for future convenience. This option is not available to the Administrator for obvious reason.

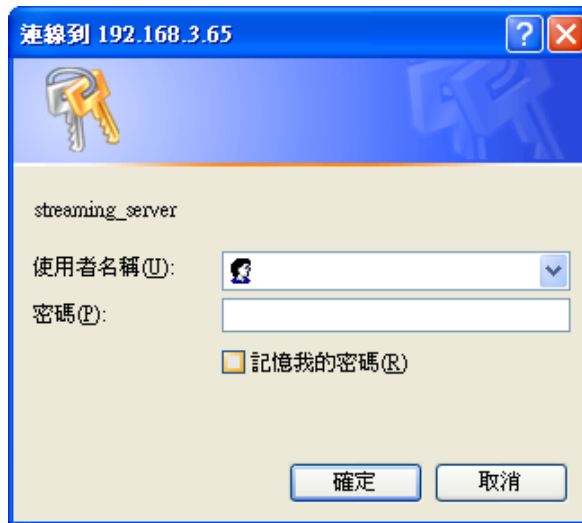

Installing plug-in

For the initial access to the Network Camera in Windows, the web browser may prompt for permission to install a new plug-in for the Network Camera on the Internet Explorer. Permission request depends on the Internet security settings of the user's PC or notebook. If the highest security level is set, the computer may prohibit any installation and execution attempt. This plug-in has been registered for certificate and is used to display the video in the browser. Users may click on to proceed. If the web browser does not allow the user to continue to install, check the Internet security option and lower the security levels or contact your IT or networking supervisor for help.



Primary user's capability

Main Screen with Camera View

The main page layout has two parts:

Configuration functions: The camera can be configured using these user interfaces.

Camera View: What the camera sees.

Click on the configuration link to the left of the image window to enter the configuration page.

Here is the layout in IE when it is MPEG-4 streaming.

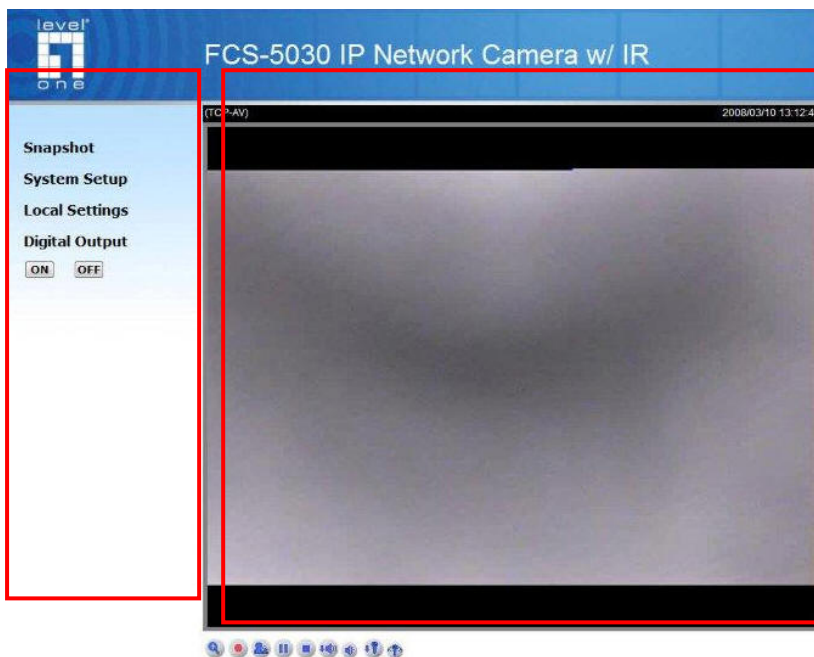

The function in JPEG will be a little different when it is JPEG streaming. Only digital zoom and record button are supported.

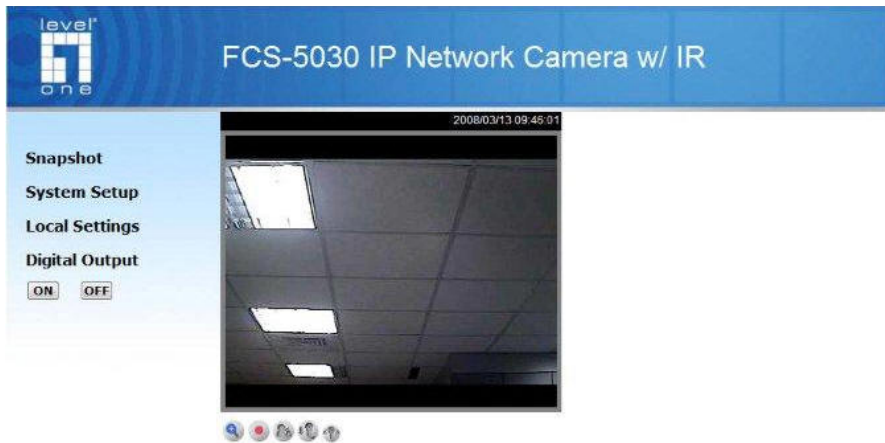

Here is the layout in Firefox when it is MPEG-4 streaming. It uses QuickTime to streaming.

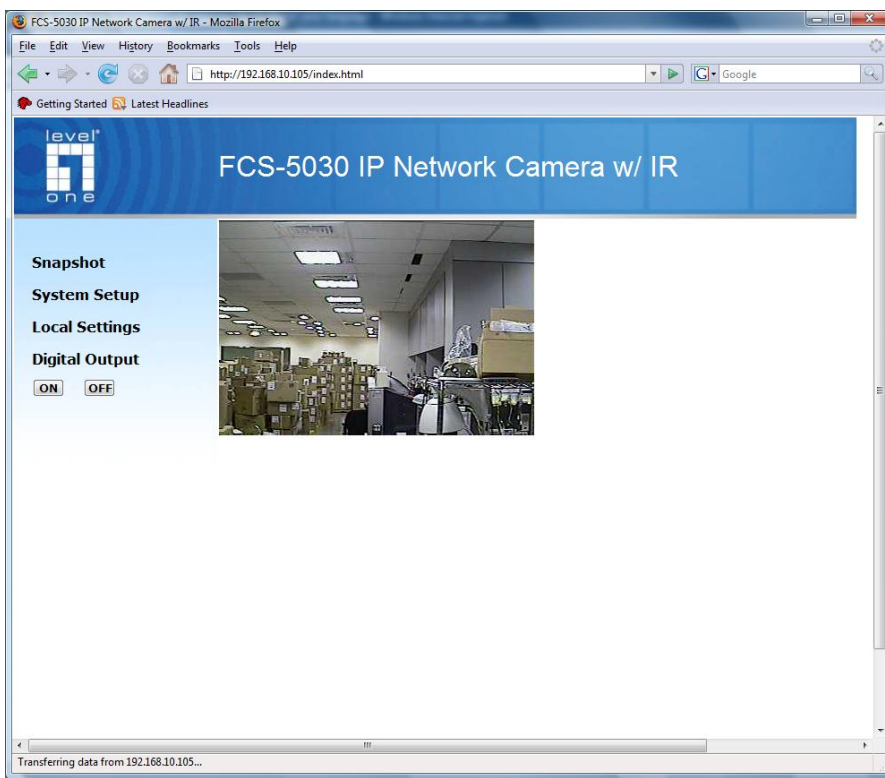

Here is the layout in Firefox when it is JPEG streaming.

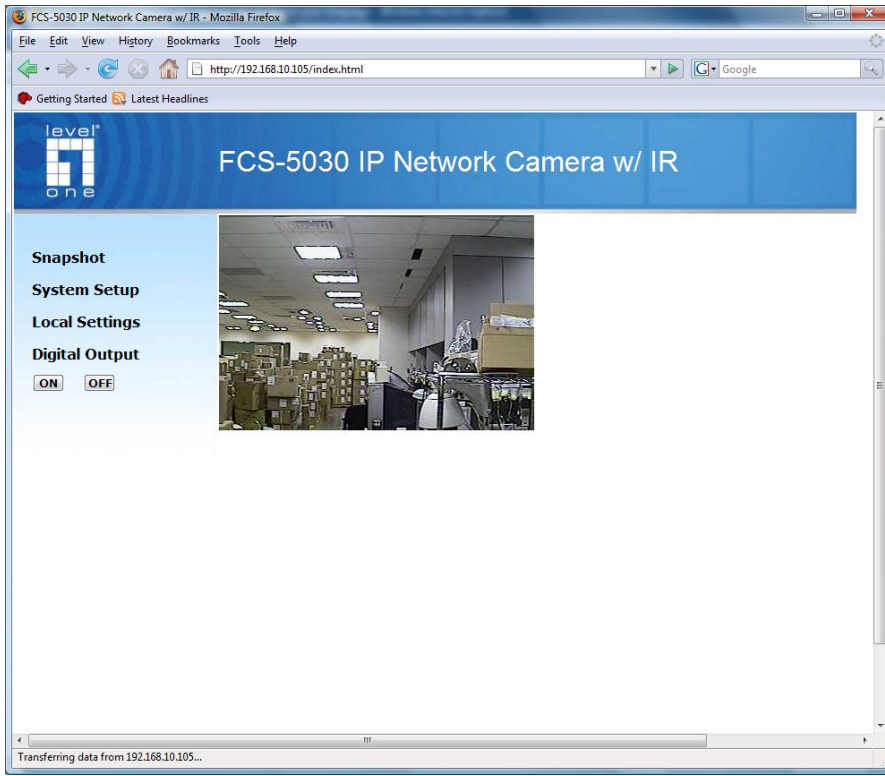

Digital Zoom

Click on the magnifier icon under the camera view then the digital zoom control panel will be shown. Uncheck "Disable digital zoom" and use the slider control to change the zoom factors.

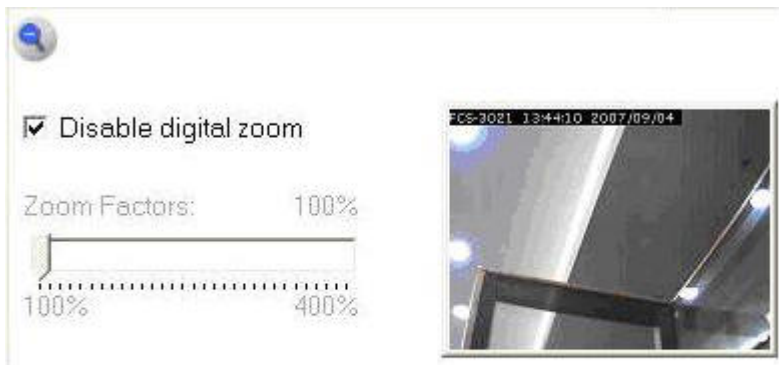

MP4 Recording

Click on the red circle button  on the plugin to start MP4 recording. You can set the related options in client setting page.

Snapshot

Click on **“Snapshot”**, web browser will pop up a new window to show the snapshot. Users can point at the snapshot and click the right button of mouse to save it.

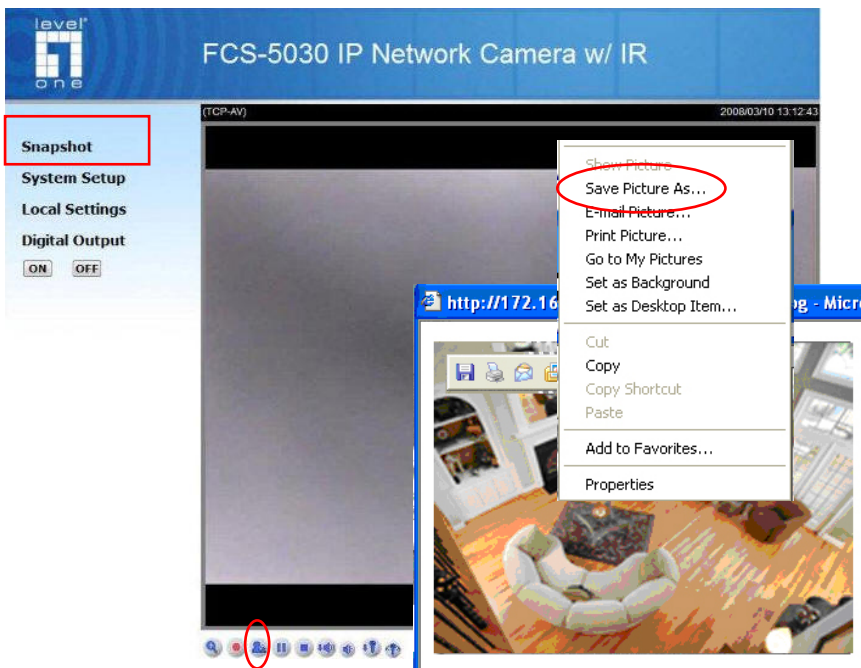

Local Settings

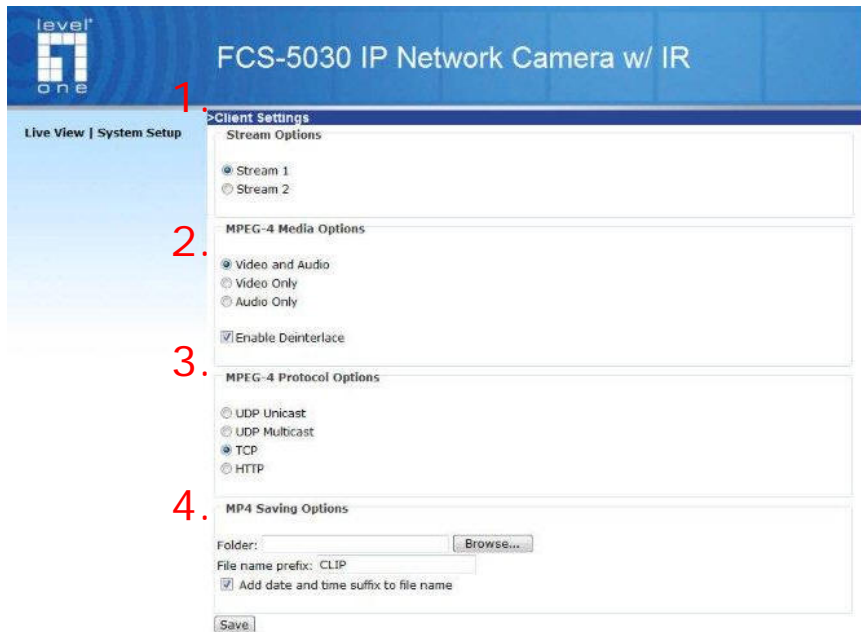

There are four settings for the client side in IE.

1. The first one is “**Stream Options**” for users to determine which stream to be streaming. This product supports dual-stream. Therefore, there are two streams to choose.
2. The second one is “**MPEG-4 Media Options**” for users to determine which media to be streaming under MPEG-4 mode.
3. The third one is “**MPEG-4 Protocol Options**” which allows choices on connection protocol between client and server. There are four protocols choices to optimize your usage – UDP unicast, UDP multicast, TCP and HTTP.
 - The **UDP unicast** protocol allows for more real-time audio and video streams. However, some packets may be lost due to network burst traffic and images may be obscured.
 - The **UDP multicast** protocol allows to save the bandwidth of server while serving multiple clients at the same time.
 - The **TCP** protocol allows for less packet loss and produces a more accurate video display. The downside with this protocol is that the real-time effect is worse than that with the UDP protocol.
 - The **HTTP** protocol allows the same quality as TCP protocol and the user don't need to open specific port to streaming under some network environment.

If no special need is required, UDP unicast protocol is recommended. Generally speaking, the client's choice will be in the order of UDP multicast → UDP unicast → TCP → HTTP. After

the Network Camera is connected successfully, "Protocol Option" will indicate the selected protocol. The selected protocol will be recorded in the user's PC and will be used for the next connection. If the network environment is changed, or the user wants to let the web browser to detect again, manually select the UDP protocol, save, and return HOME to re-connect.

4. The fourth one is "**MP4 Save Options**". User can specify the recording folder, file name prefix and suffix here.

There is only one setting "**Stream Options**" for the client setting side in Firefox. User can choose to view stream1 and stream2.

<url> *http://<Network Camera>/clientset.html* <Network Camera> is the domain name or the original IP address of the Network Camera.

Digital output

Click on "ON", the digital output of the Network Camera will be triggered. Or, clicking on "OFF" can let the digital output turn into normal state.

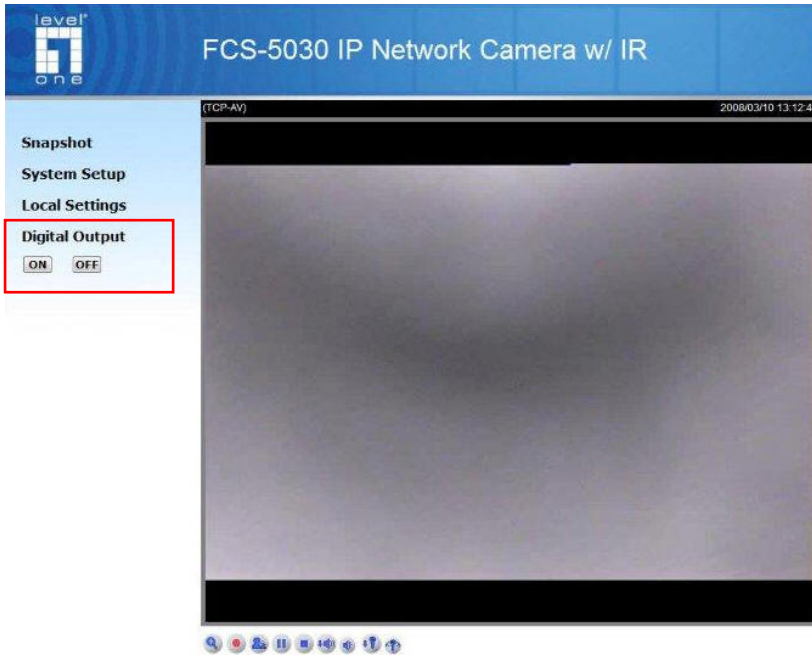

Administrator's capability

Fine-tuning for Best Performance

Best performance generally equates to the fastest image refresh rate with the best video quality, and at the lowest network bandwidth as possible. The three factors, "Maximum frame rate", "Constant bit rate", and "Fixed quality" for MPEG-4 mode and "Maximum frame rate" and "Fixed quality" for JPEG mode on the Audio and Video Configuration page, are correlative to allow for achieving the best performance possible.

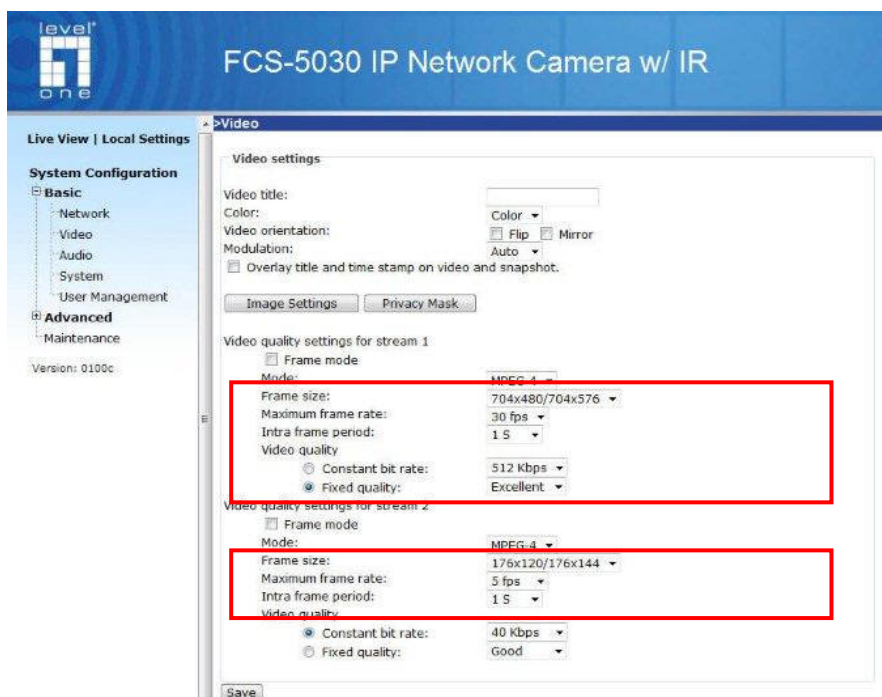

For Viewing by Mobile Phone

Most 3GPP cell phone supports media streaming with MPEG4 video and GSM-AMR audio. Due to the limitation of the bandwidth for 3GPP, only 176x144 video solution will be supported for cell phone viewing. Please set related video settings first as mentioned when viewing by mobile phone.

For Best Real-time Video Images

To achieve good real-time visual effect, the network bandwidth should be large enough to allow a transmission rate of greater than 20 image frames per second. If the broadband network is over 1 Mbps, set the "Constant bit rate" to 1000Kbps or 1200Kbps, or set "Fixed quality" at the highest quality. The maximum frame rate is 30. If your network bandwidth is more than 512Kbps, you can adjust the bit rate according to your bandwidth and set the maximum frame rate to 30 fps. If the

images vary dramatically in your environment, you may want to slow the maximum frame rate down to 20 fps in order to lower the rate of data transmission. This allows for better video quality and the human eyes cannot readily detect the differences between those of 20, 25, or 30 frames per second. If your network bandwidth is below 512 Kbps, set the “Constant bit rate” according to your bandwidth and try to get the best performance by fine-tuning with the “Maximum frame rate”. In a slow network, greater frame rate results in blur images. Video quality performance will vary somewhat due to the number of users viewing on the network; even when the parameters have initially been finely tuned. Performance will also suffer due to poor connectivity because of the network’s burst constraint.

Only Quality Images Will Do

To have the best video quality, you should set “Fixed quality” at “Detailed” or “Excellent” and adjust the “Maximum frame rate” to match your network’s bandwidth. If your network is slow and you receive “broken” pictures, go to the TCP or HTTP protocol in “MPEG-4 Protocol Options” and choose a more appropriate mode of transmission. The images may suffer a time delay due to a slower connection. The delay will also increase with added number of users.

Somewhere Between Real-time and Clear Images

If you have a broadband network, set “Fixed quality” at “Good” or better, rather than setting “Constant bit rate”. You can also fix the bandwidth according to your actual network speed and adjust the frame rate. Start from 30 fps down for best results but not below 15 fps. If the image qualities are not improved, select a lower bandwidth setting.

Opening accounts for new use

level
one

FCS-5030 IP Network Camera w/ IR

Live View | Local Settings

System Configuration

- Basic
 - Network
 - Video
 - Audio
 - System
 - User Management
- Advanced
- Maintenance

Version: 0100c

User Management

1

Root Password

Note: Leaving the root password field empty means the camera will not be protected by password.

Root Password:

Confirm root password:

Save

2

Add User

User name:

User password:

User type:

Administrator

Operator

Viewer

Add

3

Manage User

User name:

User password:

User type:

Administrator

Operator

Viewer

Save Delete

Protect Network Camera by passwords

The Network Camera is shipped without any password by default. That means everyone can access the Network Camera including the configuration as long as the IP address is known. It is necessary to assign a password if the Network Camera is intended not to be accessed by others. Type a new word twice in ① to enable protection. This password is used to identify the administrator. Then add an account with user name, password and authentication for your friends in ②. You can edit or delete users from ③.

Build a security application

The Administrator can use the built-in motion detection to monitor any movement to perform many useful security applications. To upload the snapshots, users can choose either email, FTP, HTTP or Network storage according to user's needs. All servers setting are in Server section on Application page. Refer to the definition section for detail configuration.

1. Click on "**Configuration**" on homepage,
2. Click on "**Motion detection**" at the left column,
3. Check "Enable motion detection",
4. Click on new to have a new window to monitor video,
5. Type in a name to identify the new window,
6. Use the mouse to click, hold, and drag the window corner to resize or the title bar to move
7. Fine-tune using the "Sensitivity" and "Percentage" fields to best suit the camera's environment. Higher "Sensitivity" detects the slighter motion. Higher "Percentage" discriminates smaller objects,
8. Clicking on "Save" enables the activity display. Green means the motion in the window is under the watermark set by Administrator and red means it is over the watermark,
9. Click on "**Application**" at the left column,
10. Add a server in server section,
11. Add a media with snapshot type in media section. And Set the number of pre-event and post-event images to be uploaded
12. Add a event in event section
 - Enter one event name and enable this event.
 - Check the weekdays as you need and give the time interval to monitor the motion detection every day,
 - Select the Trigger on Motion detection and Check the window name set in step 5
 - Set the appropriate delay time to avoid continuous false alarms following the original event
 - Check the server name set in Step 10 and select the media name set in Step 11.
13. Click on save to validate.

Software revision upgrade

Customers can obtain the up-to-date software from the web site of LevelOne. An easy-to-use Upgrade Wizard is provided to upgrade the Network Camera with just a few clicks. The upgrade function is opened to the Administrator only. To upgrade the system, follow the procedures below.

1. Download the firmware file named “xxx.pkg” from the appropriate product folder.
2. Run the Installation Wizard and proceed following the prompts. Refer to the instructions of the Installation Wizard on CD-ROM for details.
3. Or upgrade firmware from HTTP web page directly.
4. The whole process will finish in a few minutes and it will automatically restart the system.



If power fails during the writing process of Flash memory, the program in the memory of the Network Camera may be destroyed permanently. If the Network Camera cannot restart properly, ask your dealer for technical service.

Definitions in Configuration

Only the Administrator can access system configuration. Each category in the left column will be explained in the following pages. The bold texts are the specific phrases on the Option pages. The Administrator may type the URL below the figure to directly enter the frame page of configuration. If the Administrator also wants to set certain options through the URL, read the reference appendix for details.

Basic-Network

Any changes made on the Network type section will restart the system in order to validate the changes. Make sure every field is entered correctly before clicking on **Save**.

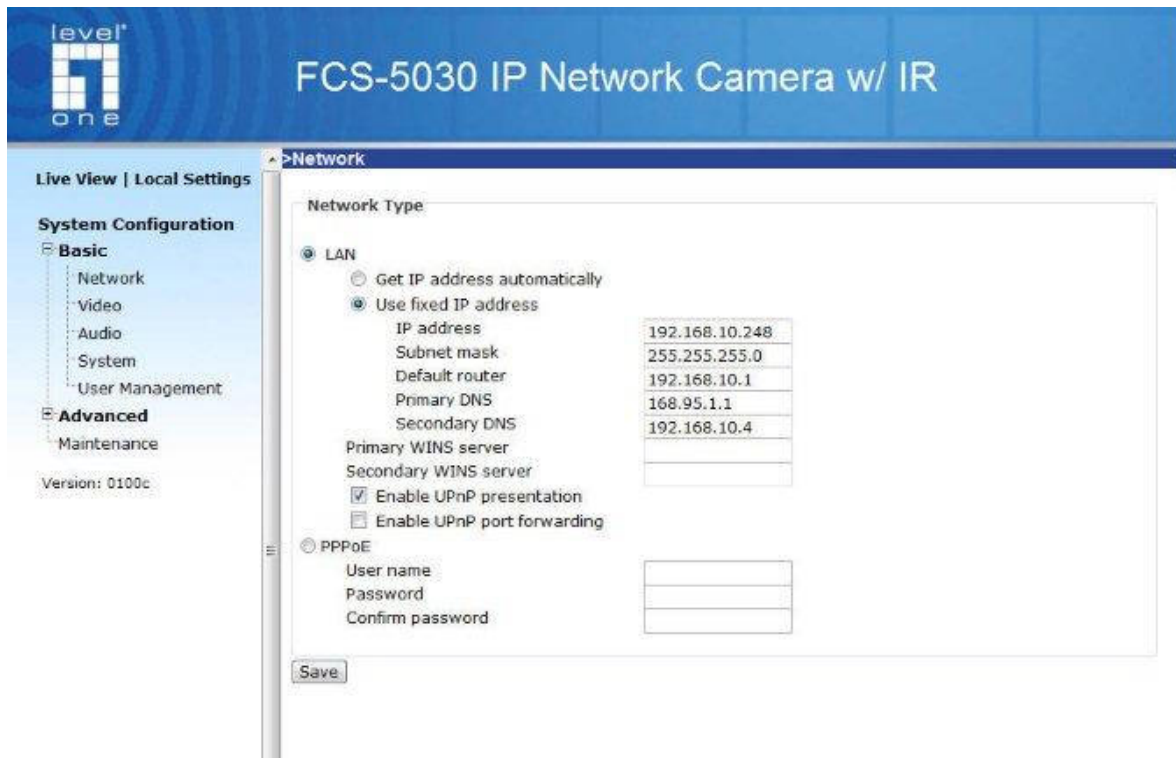

Network type

“LAN” & “PPPoE”

The default type is LAN. Select PPPoE if using ADSL

“Get IP address automatically” & “Use fixed IP address”

The default status is “Get IP address automatically”. This can be tedious having to perform software installation whenever the Network Camera starts. Therefore, once the network settings, especially the IP address, have been entered correctly, select “Use fixed IP address” then the

Network Camera will skip installation at the next boot. The Network Camera can automatically restart and operate normally after a power outage. Users can run IP installer to check the IP address assigned to the Network Camera if the IP address is forgotten or using the UPnP function provided by the Network Camera (MS Windows XP provides UPnP function at **My Network Place**). **“IP address”** This is necessary for network identification.

“Subnet mask” This is used to determine if the destination is in the same subnet. The default value is “255.255.255.0”.

“Default router” This is the gateway used to forward frames to destinations in a different subnet. Invalid router setting will fail the transmission to destinations in different subnet.

“Primary DNS” The primary domain name server that translates hostnames into IP addresses.

“Secondary DNS” Secondary domain name server that backups the Primary DNS.

“Primary WINS server” The primary WINS server that maintains the database of computer name and IP address.

“Secondary WINS server” The secondary WINS server that maintains the database of computer name and IP address.

“Enable UPnP presentation” Enable the UPnP camera short cut.

“Enable UPnP port forwarding” Enable UPnP port forwarding

“PPPoE” If using the PPPoE interface, fill the following settings from ISP

“User name” The login name of PPPoE account

“Password” The password of PPPoE account

“Confirm password” Input password again for confirmation

Audio and Video

This product supports dual-stream. It provides two setting for video streams, but only one setting for audio.

Video Settings

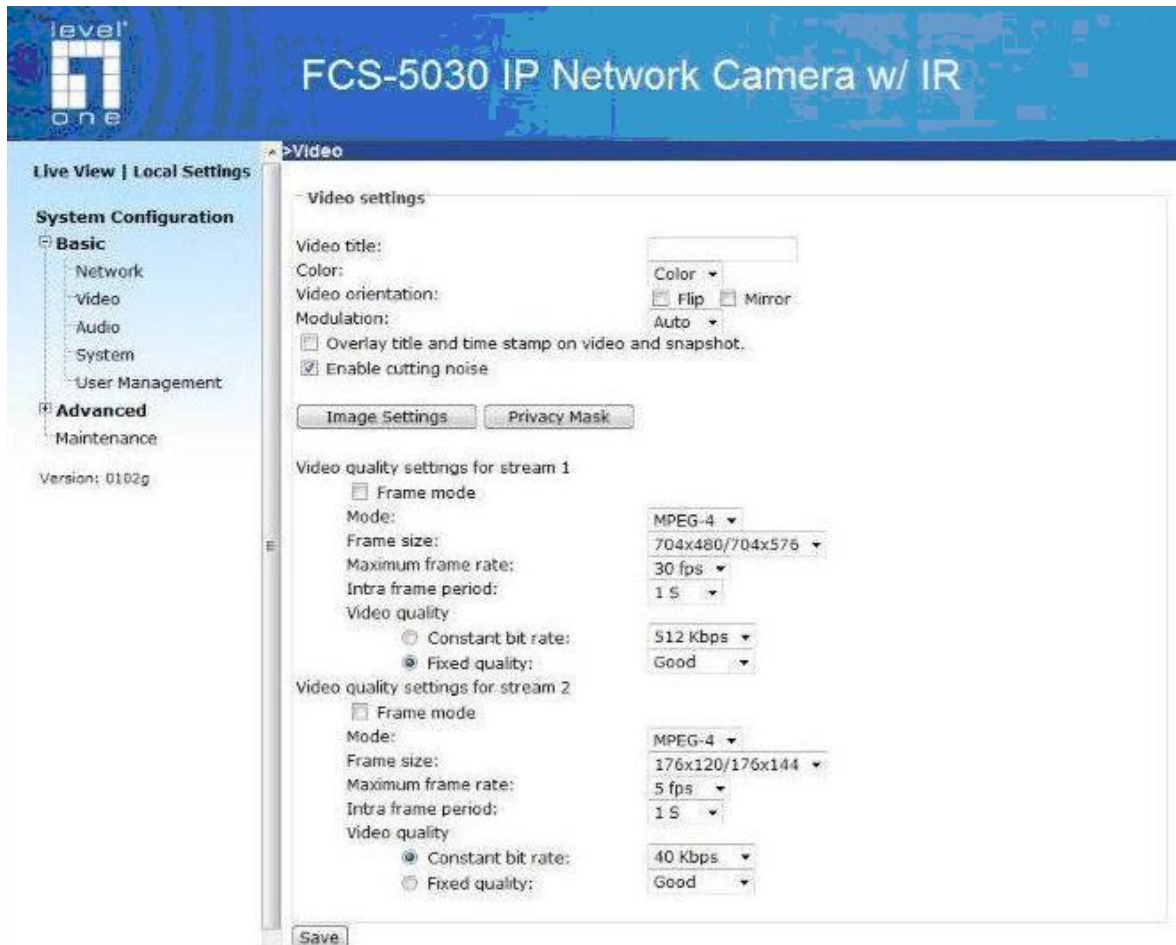

“**Video title**” The text string can be displayed on video

“**Color**” Select either for color or monochrome video display.

“**Video orientation**”

- **Flip:** Vertically rotate the video.
- **Mirror:** Horizontally rotate the video. Check options both if the Network Camera is installed upside down.

“**Modulation**” Select the video input modulation types, NTSC, PAL, and Auto. After Change the modulation type, please reboot the video server to make the change take effect.

“Overlay title and time stamp on video and snapshot” Check it the title is shown on video and snapshot.

“Enable cutting noise” Check it for PAL camera. The resolution will be compromised to 688*576 or 688*480 once this setting is checked.

There are different video quality settings for stream1 and stream2.

- **Mode:** It can be MPEG-4 or JPEG. If MPEG-4 is selected, it is streamed in RTSP protocol. If JPEG is selected, it is streamed in server push mode.
- **Frame size:** Both MPEG-4 and JPEG have three options, including **“QCIF (176x120 NTSC and 176x144 PAL)”**, **“CIF (352x240 NTSC and 352x288 PAL)”**, and **“4CIF (704x480 NTSC and 704x576 PAL)”**.

There are three dependent parameters provided in MPEG-4 mode for video performance adjustment.

“Intra frame period” The interval of intra frame.

“Maximum frame rate” This limits the maximal refresh frame rate, which can be combined with the **“Video quality”** to optimize bandwidth utilization and video quality. Choose **“Constant bit rate”** If the user wants to fix the bandwidth utilization regardless of the video quality, choose **“Fixed quality”** and select the desired bandwidth. The video quality may be poor due to the sending of maximal frame rate within the limited bandwidth when images are moving rapidly. Consequently, to ensure detailed video quality (quantization rate) regardless of the network, it will utilize more bandwidth to send the maximal frames when images change drastically.

In JPEG mode, user can set **“Maximum frame rate”** and **“Video quality”** to adjust the video performance.

Audio settings

“Mute” Turn off audio.

“Input gain” Modify the gain of the internal audio input.

“Audio type” Select audio codec **“AAC”** or **“GSM-AMR”** and the bit rate.



Image Settings

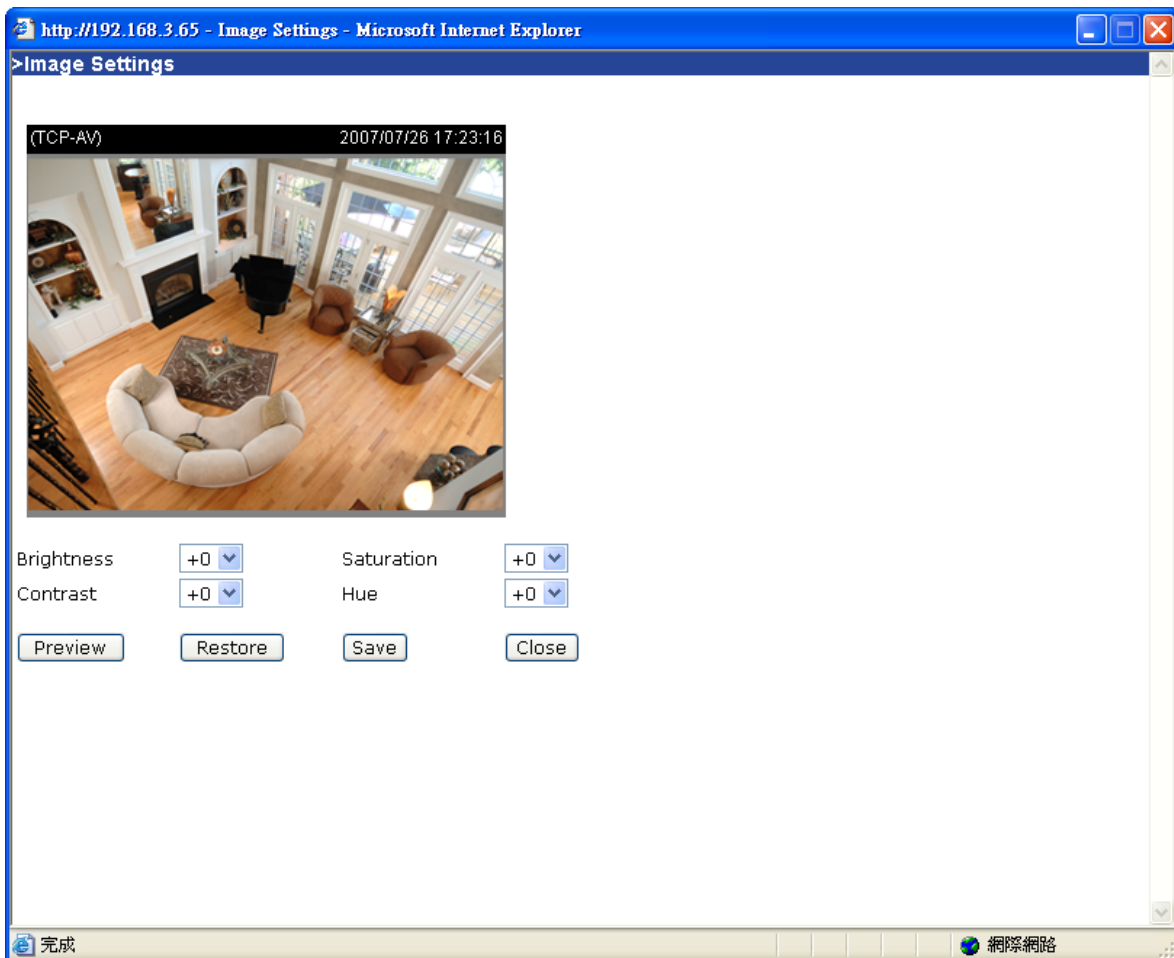
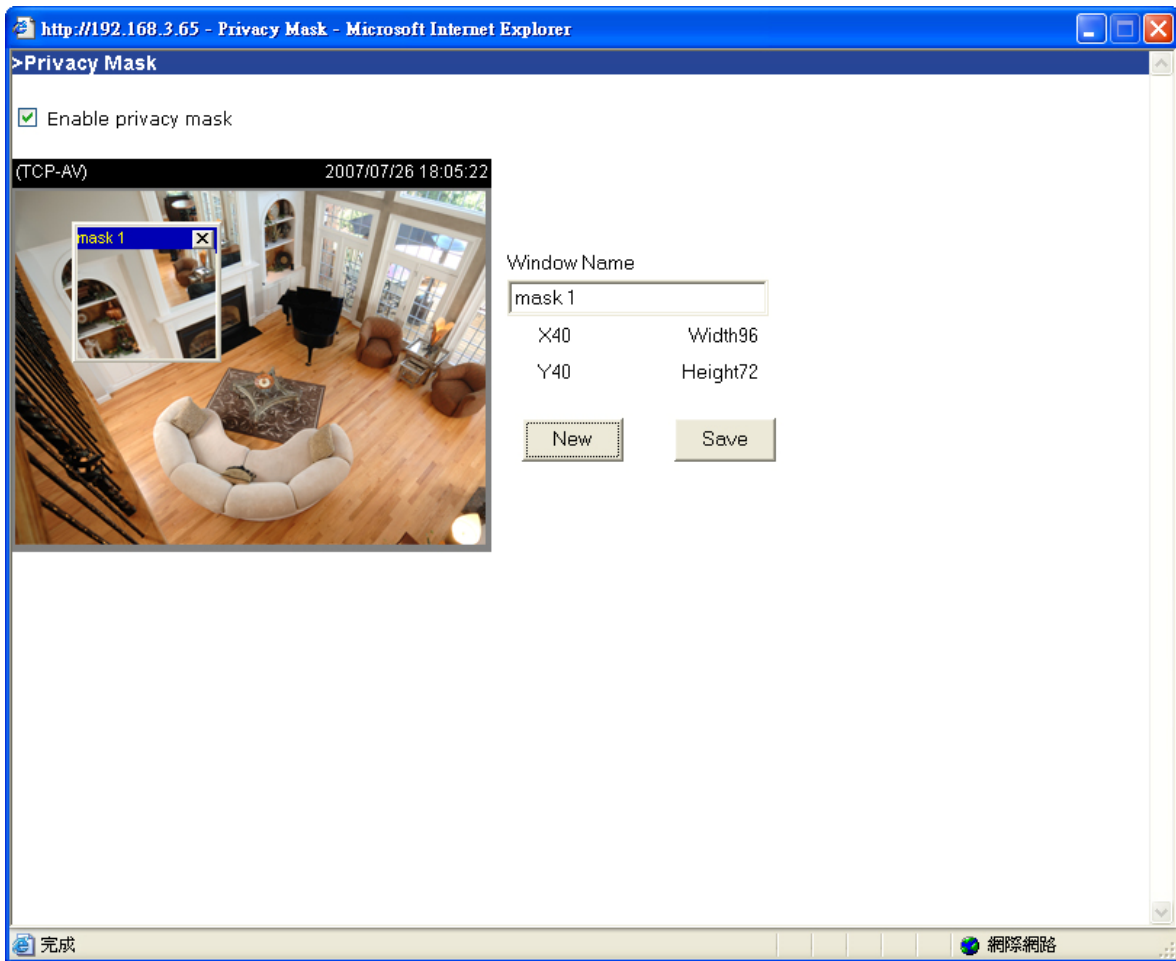

Image Settings

Click on this button to pop up another window to tune "Brightness",

“Contrast”, **“Hue”** and **“Saturation”** for video compensation. Each field has eleven levels ranging from -5 to +5. In **“Brightness”** and **“Contrast”** fields the value 0 indicates auto tuning. The user may press to fine-tune the image. When the image is O.K., press to set the image settings. Click on to recall the original settings without incorporating the changes.

Privacy Mask



Click on the button to pop up another window to set privacy mask window. All users can not view the block under privacy mask window.

“Enable privacy mask” Check this option to turn on privacy mask.

New Click on this button to add a new window. At most five windows can exist simultaneously. Use the mouse to click, hold, and drag the window frame to resize or the title bar to move. Clicking on the ‘x’ at the upper right-hand corner of the window deletes the window. Remember to click save in order to validate the changes. The base of window axis is eight. You can see the X, Y, width and height of the window.

Save Click on this button to save the related window settings.

“Window Name” The text will show at the top of the window.

The following figure shows the screen when **Save** is clicked and the privacy mask is enabled.

http://192.168.3.65 - Privacy Mask - Microsoft Internet Explorer

>Privacy Mask

Enable privacy mask

(TCP-AV) 2007/07/27 11:01:47



mask

Window Name

mask

X96 Width96

Y48 Height72

New Save

完成 網際網路

System

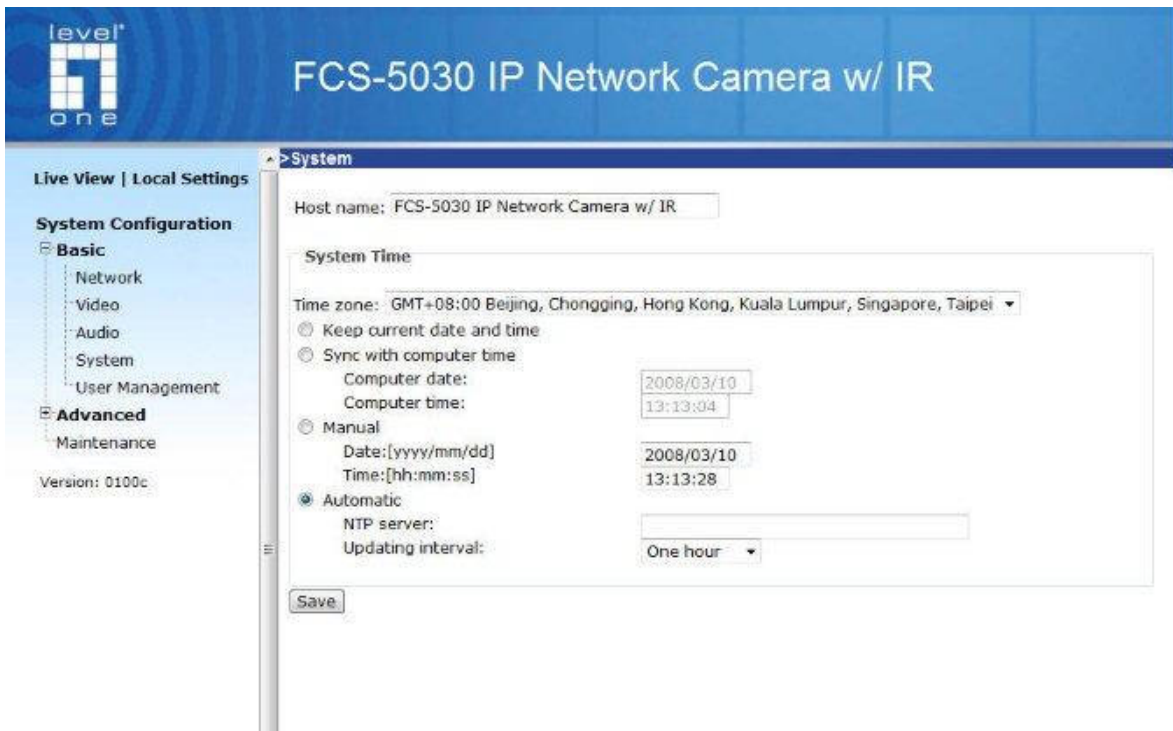

"Host name" The text displays the title at the top of the main page.

"Time zone" Adjust the time with that of the time-servers for local settings.

"Keep current date and time" Click on this to reserve the current date and time of the Network Camera. An internal real-time clock maintains the date and time even when the power of the system is turned off.

"Sync with computer time" Synchronize the date and time of the Network Camera with the local computer. The read-only date and time of the PC is displayed as updated.

"Manual" Adjust the date and time according to what is entered by the Administrator. Notice the format in the related fields while doing the entry.

Network Camera starts up. It will fail if the assigned time-server cannot be reached.

"Automatic" **"NTP server"** Assign the IP address or domain name of the time-server. Leaving the text box blank connects the Network Camera to the default time-servers.

"Update interval" Select hourly, daily, weekly, or monthly update with the time on the NTP server.

User Management

The screenshot shows the web interface for the FCS-5030 IP Network Camera. The top navigation bar includes the 'level one' logo and the camera model name. The left sidebar shows 'System Configuration' with sub-items: Basic (Network, Video, Audio, System, User Management), Advanced, and Maintenance. The main content area is titled 'User Management' and contains three sections:

- Root Password:** A note states that leaving the root password field empty means the camera will not be protected by password. There are two text input fields for 'Root Password' and 'Confirm root password', both containing asterisks. A 'Save' button is located below.
- Add User:** Fields for 'User name', 'User password', and 'User type'. The 'User type' section has three radio buttons: 'Administrator' (selected), 'Operator', and 'Viewer'. An 'Add' button is below.
- Manage User:** A dropdown menu for 'User name', a text input for 'User password', and 'User type' radio buttons (Administrator, Operator, Viewer). 'Save' and 'Delete' buttons are at the bottom.

“Root password” Change the Administrator’s password by typing in the new password identically in both text boxes. The typed entries will be displayed as asterisks for security purposes. After pressing **Save**, the web browser will ask the Administrator for the new password for access.

“Add user” Type the new user's name and password and press **Add** to insert the new entry. The new user will be displayed in the user name list. There is a maximum of twenty user accounts. There are three kinds of authentication: Administrator, Operator and Viewer. Administrator can fully control the camera operation. Operator’s access right can modify most of camera’s parameters except some privilege and network options. Viewer can view, listen to camera; control DIDO of camera. Network Camera can provide twenty accounts for your valuable customers or friends.

“Manage user” Pull down the user list to find the user’s name and press **Delete** to delete the selected user. Or edit the password or authentication of the selected user and press **Save** to take effect.

Advanced-Network

The screenshot displays the web interface for the FCS-5030 IP Network Camera. The top header includes the 'level one' logo and the device name 'FCS-5030 IP Network Camera w/ IR'. The main content area is titled '>Network' and contains several configuration sections:

- DDNS: Dynamic domain name service:** Includes a checkbox for 'Enable DDNS', a 'Provider' dropdown menu set to 'Dyndns.org(Dynamic)', and input fields for 'Host name', 'User name', and 'Password'. A 'Save' button is located below these fields.
- HTTP:** Includes a dropdown for 'Authentication' set to 'basic', and input fields for 'HTTP port' (80), 'Secondary HTTP port' (8080), 'Access name for stream 1' (video.mjpg), and 'Access name for stream 2' (video2.mjpg).
- Two way audio:** Includes an input field for 'Two way audio port' set to 5060.
- FTP:** Includes an input field for 'FTP port' set to 21.

A left-hand navigation menu is visible, showing 'System Configuration' with sub-sections for 'Basic' (Network, Video, Audio, System, User Management) and 'Advanced' (Network, IP Filtering, Motion detection, Event Setup, Recording, Peripherals, System log, Maintenance). The version number 'Version: 0100c' is displayed at the bottom left of the interface.

RTSP Streaming

Authentication:

Access name for stream 1:

Access name for stream 2:

RTSP port:

RTP port for video:

RTCP port for video:

RTP port for audio:

RTCP port for audio:

Multicast settings for stream 1

Always multicast

Multicast group address:

Multicast video port:

Multicast RTCP video port:

Multicast audio port:

Multicast RTCP audio port:

Multicast TTL [1~255]:

Multicast settings for stream 2

Always multicast

Multicast group address:

Multicast video port:

Multicast RTCP video port:

Multicast audio port:

Multicast RTCP audio port:

Multicast TTL [1~255]:

DDNS

“Enable DDNS” This option turns on the DDNS function.

“Provider” The provider list contains seven hosts that provide DDNS services. Please connect to the service provider’s website to make sure the service charges.

“Host Name” If the User wants to use DDNS service, this field must be filled. Please input the hostname that is registered in the DDNS server.

“Username/E-mail” The Username or E-mail field is necessary for logging in the DDNS server or notify the User of the new IP address. Note: when this field is input as “Username” the following field must be input as “Password”.

“Password/Key” Please input the password or key to get the DDNS service.

“Save” Click on this button to save current settings for the DDNS service and UPnP function.

HTTP

“Authentication” It supports basic and digest modes.

“HTTP port” This can be other than the default Port 80. Once the port is changed, the users must

be notified the change for the connection to be successful. For instance, when the Administrator changes the HTTP port of the Network Camera whose IP address is 192.168.0.100 from 80 to 8888, the users must type in the web browser “http://192.168.0.100:8888” instead of “http://192.168.0.100”.

“**Secondary HTTP port**” It support alternate port to access HTTP server.

“**Access name for stream 1**” This is the access URL of stream 1 for making connection from client software when its codec type is JPEG.

“**Access name for stream 2**” This is the access URL of stream 2 for making connection from client software when its codec type is JPEG.

Using http://<ip address>:<http port>/<access name> to make connection.

Two way audio

“**Two way audio port**” This can be other than the default port 5060. The user can change this value from 1025 to 65535. After the changed, the external Two-Way audio client program must change the server port of connection accordingly.

FTP

“**FTP port**” This can be other than the default port 21. The user can change this value from 1025 to 65535. After the changed, the external FTP client program must change the server port of connection accordingly.

RTSP Streaming

“**Authentication**” It supports disable, basic and digest modes.

“**Access name for stream 1**” This is the access URL of stream 1 for making connection from client software when the codec type is MPEG-4.

“**Access name for stream 2**” This is the access URL of stream 2 for making connection from client software when the codec type is MPEG-4.

Using rtsp://<ip address>/<access name> to make connection

“**RTSP port**” This can be other than the default Port 554

“**RTP port for video**” The video channel port for RTP. It must be an even number.

“**RTCP port for video**” The video channel port for RTCP. It must be the port number of video RTP plus 1.

“**RTP port for audio**” The audio channel port for RTP. It must be an even number.

“**RTCP port for audio**” The audio channel port for RTCP. It must be the port number of audio

RTP plus 1.

User can modify Multicast setting for stream1 and stream2.

“Always multicast” Select it to enable multicast always.

“Multicast group address” It is used by sources and the receivers to send and receive content.

“Multicast video port” The video channel port for multicast. It must be an even number.

“Multicast RTCP video port” The video channel port for multicast RTCP. It must be the port number of multicast video port plus 1.

“Multicast audio port” The audio channel port for multicast. It must be an even number.

“Multicast RTCP audio port” The audio channel port for multicast RTCP. It must be the port number of multicast audio port plus 1.

“Multicast TTL” It specifies the number of routers (hops) that multicast traffic is permitted to pass through before expiring on the network.

IP Filtering

The screenshot displays the 'IP Filtering' configuration interface. On the left, a navigation menu includes 'System Configuration' with sub-items like 'Basic' (Network, Video, Audio, System, User Management) and 'Advanced' (Network, IP Filtering, Motion detection, Event Setup, Recording, Peripherals, System log, Maintenance). The main area is titled 'IP Filtering' and contains two sections: 'Allowed list' and 'Denied list'. Each section has a 'Starting IP address' and 'Ending IP address' text box, an 'Add' button, and a 'Delete allowed list' or 'Delete denied list' section with a pull-down menu and a 'Delete' button. The 'Allowed list' pull-down menu currently shows '1.0.0.0 ~ 255.255.255.255'. The version '0100c' is noted at the bottom left.

The access list is to control the access permission of clients by checking the client IP address.

There are two lists for permission control: **Allow List** and **Deny List**. Only those clients whose IP address is in the **Allow List** and not in the **Deny List** can connect to the Video Server or Network Camera for receiving the audio/video streaming.

Both **Allow List** and **Deny List** consist of a list of IP ranges. If you want to add a new IP address range, type the **Start IP Address** and **End IP Address** in the text boxes and click on the **Add** button. If you want to remove an existing IP address range, just select from the pull-down menu and click on the **Delete** button.

Both the Allow List and Deny List can have 10 entries.

Motion detection

“Enable motion detection” Check this option to turn on motion detection.

New Click on this button to add a new window. At most three windows can exist simultaneously. Use the mouse to click, hold, and drag the window frame to resize or the title bar to move. Clicking on the ‘x’ at the upper right-hand corner of the window deletes the window. Remember to save in order to validate the changes.

Save Click on this button to save the related window settings. A graphic bar will rise or fall depending on the image variation. A green bar means the image variation is under monitoring level and a red bar means the image variation is over monitoring level. When the bar goes red, the detected window will also be outlined in red. Going back to the homepage, the monitored window is hidden but the red frame shows when motion is detected.

“Window Name” The text will show at the top of the window.

“Sensitivity” This sets the endurable difference between two sequential images.

“Percentage” This sets the space ratio of moving objects in the monitoring window. Higher sensitivity and small percentage will allow easier motion detection.

The following figure shows the screen when **Save** is clicked.

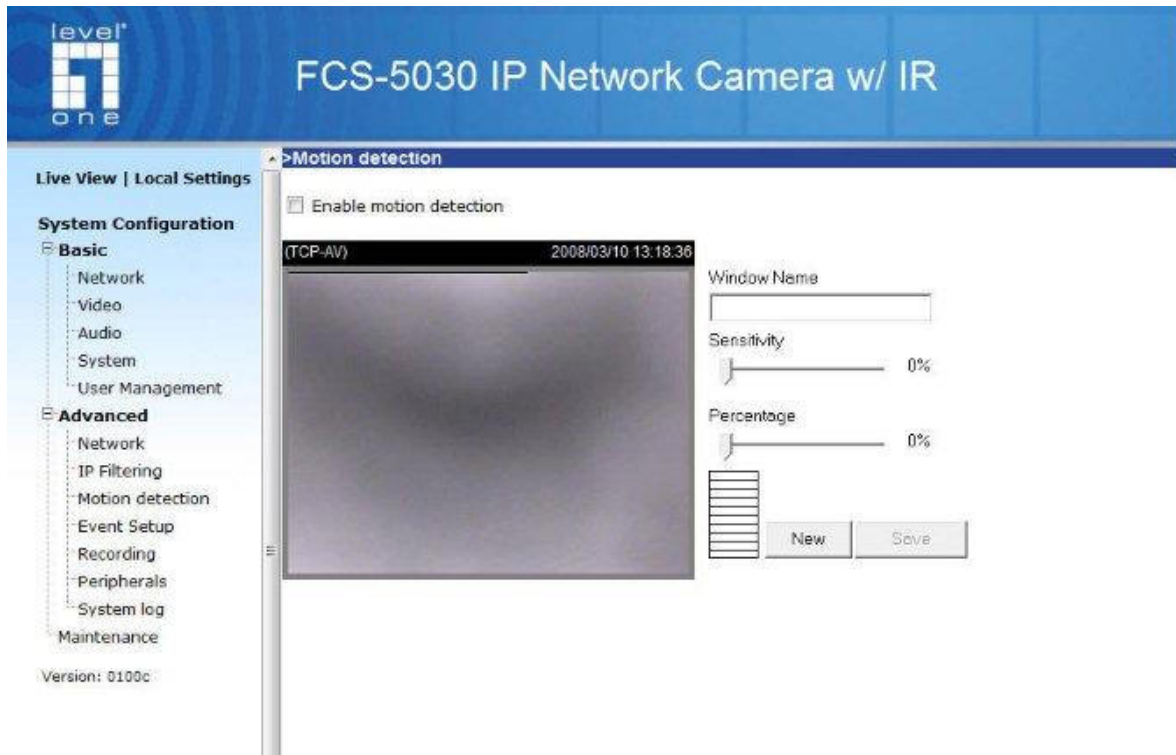

Event Setup

There are three sections in application page. They are event, server and media. Click **Add** to pop a window to add a new item of event, server or media. Click **Delete** to delete the selected item from event, server or media. Click on the item name to pop a window to edit it.

There can be at most three events. There can be at most five server and five media configurations.

User can know the event name, status, weekly and time schedule and trigger type in event section. The server name, type and address/location are shown in server section.

The current media free space, media name and type are shown in media section. After adding a new media, the value of free space will be updated. User cannot add media which size is larger than media free space.

It is suggested to set server and media first before setting event. The servers and medias selected in event list are not modified or deleted. Please remove them first from the event if you want to delete or modify them. Recommend that using different media in different event to make use all media be produced and received correctly. If using the same media in different events and the events trigger almost simultaneously, the servers in the second triggered event will not receive any media; there would be only notifications.

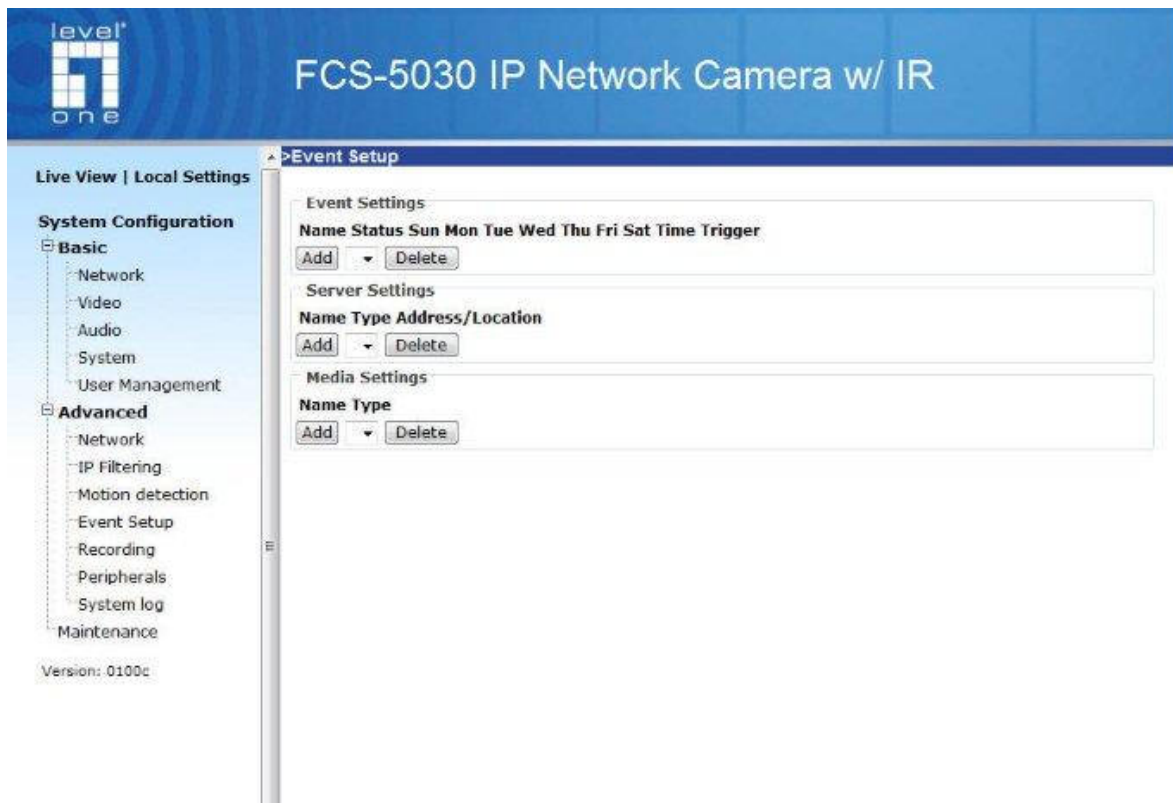

Event

>Event Settings

Event name:

Enable this event

Priority: Normal ▾

Detect next event after second(s).

Trigger

- Video motion detection
Detect motion in window
Note: Please configure [Motion detection](#) first
- Periodically
Trigger every other minutes
- Digital input
- System boot

Event Schedule

Sun Mon Tue Wed Thu Fri Sat

Time

- Always
- From to [hh:mm]

Action

D/O : Trigger digital output for seconds

“**Event name**” The unique name for event

“**Enable this event**” Check it to enable this event.

“**Priority**” The event with higher priority will be executed first.

“**Delay second(s) before detecting next event**” The delay to check next event. It is used in motion detection and digital input trigger type.

There are four kinds of trigger supported.

“**Video motion detection**” Select the windows which need to be monitored.

“**Periodic**” The event is triggered in specified intervals. The unit of trigger interval is minute.

“**Digital input**” To monitor digital input

“**System boot**” The event is triggered when the system boots up.

The weekly and time schedules are provided.

“**Sun**” ~ “**Sat**” Select the days of the week to perform the event.

“**Time**” show “**Always**” or input the time interval.

The default action is triggering DO. If there are servers configured, the user can select them from “**Server name**”, too.

“**D/O**” Check it to trigger digital output for specific seconds when event is triggered.

Server

Server name: mail

Server type

Email

Sender email address: winson@ddcasia.com.tw

Recipient email address: winson@ddcasia.com.tw

Server address: ms32.hinet.net

User name: []

Password: []

FTP

Server address: []

Server port: 21

User name: []

Password: []

Remote folder name: []

Passive mode

HTTP

URL: http:// []

User name: []

Password: []

Network storage

Network storage location: []

(for example: \\my_nas\disk\folder)

Workgroup: []

User name: []

Password: []

Test **Save** **Close**

“**Server**

name” The unique name for server

There are four kinds of servers supported. They are email server, FTP server, HTTP server and network storage.

Here is setting for email server.

“**Sender email address**” The email address of the sender

“**Recipient email address**” The email address of the recipient

“**Server address**” The domain name or IP address of the external email server.

“**User name**” This granted user name on the external email server.

“**Password**” This granted password on the external email server.

Here is setting for FTP server.

“Server address” The domain name or IP address of the external FTP server.

“Server port” This can be other than the default port 21. The user can change this value from 1025 to 65535.

“User name” This granted user name on the external FTP server.

“Password” This granted password on the external FTP server.

“Remote folder name” Granted folder on the external FTP server. The string must conform to that of the external FTP server. Some FTP servers cannot accept preceding slash symbol before the path without virtual path mapping. Refer to the instructions for the external FTP server for details. The folder privilege must be open for upload.

“Passive Mode” Check it to enable passive mode in transmission.

Here is setting for HTTP server.

“URL” The URL to upload the media.

“User name” This granted user name on the external HTTP server.

“Password” This granted password on the external HTTP server.

Here is setting for network storage. Only one network storage is supported.

“Network storage location” The path to upload the media

“Workgroup” The workgroup for network storage.

“User name” This granted user name on the network storage.

“Password” This granted password on the network storage.

After input the setting of server, user can click on to test whether the setting is correct. The testing result will be shown in a pop-up window.

Media Setting

>Media

Media name:

Media type

Snapshot

Source:

Send pre-event image(s) [0~7]

Send post-event image(s) [0~7]

File Name Prefix:

Add date and time suffix to file name

Video Clip

Source:

Pre-event recording: seconds [0~9]

Maximum duration: seconds [1~10]

Maximum file size: Kbytes [50~800]

File Name Prefix:

System log

“Media name” The unique name for media

There are three kinds of media. They are snapshot, video clip and system log.

Here is setting for snapshot.

“Source” The source of stream, stream1 or stream2.

“Send pre-event images” The number of pre-event images

“Send post-event images” The number of post-event images

“File Name Prefix” The prefix name will be added on the file name of the snapshot images.

“Add date and time suffix to file name” Check it to add timing information as file name suffix.

Here is setting for video clip

“Source” The source of stream, stream1 or stream2.

“Pre-event recording” The interval of pre-event recording in seconds

There are two limitations for video clip file.

“Maximum duration” The maximal recording file duration in seconds

“Maximum file size” The maximal file size would be generated.

“File name prefix” The prefix name will be added on the file name of the video clip.

>Recording

Recording name:

Enable this recording

Priority: Normal ▾

Source: Stream1 ▾

Recording Schedule

Sun Mon Tue Wed Thu Fri Sat

Time

Always

From to [hh:mm]

Destination

Server Settings : ▾

Max. recording capacity

(Old file will be overwritten after reaching maximum recording capacity.): Kbytes [1000~200000000]

File size for each recording: Kbytes [200~6000]

File name prefix:

“**Recording name**” The unique name for recording entry

“**Enable this recording**” Check it to enable this event.

“**Priority**” The recording with higher priority will be executed first.

“**Source**” The source of stream, stream1 or stream2.

The weekly and time schedules are provided.

“**Sun**” ~ “**Sat**” Select the days of the week to perform the event.

“**Time**” shows “**Always**” or input the time interval.

“**Destination**” Network storage server user added.

“**Max. recording capacity**” The total size for cycle recording in Kbytes

“**File size for each recording**” The single file size in Kbytes

“**File Name Prefix**” The prefix name will be added on the file name of the recording.

Peripherals

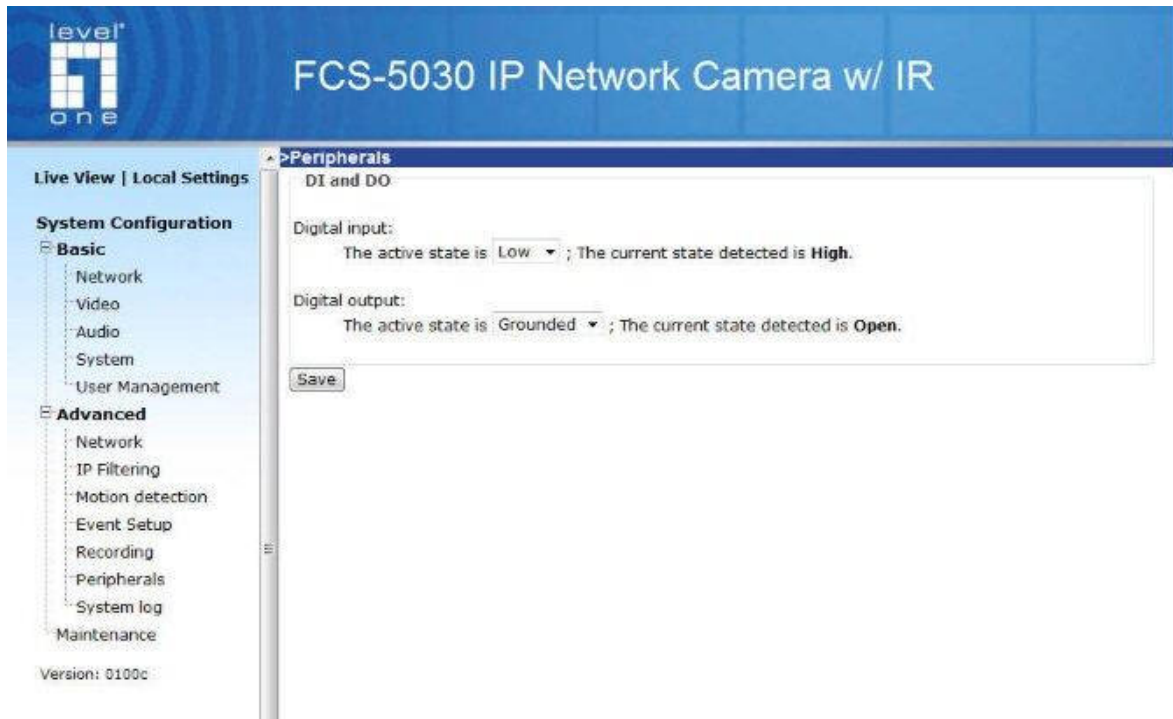

“**Digital input**” Select High or Low to define normal status of the digital input. The current status is shown, too.

“**Digital output**” Select Grounded or Open to define normal status of the digital output. The current status is shown, too.

System log

The Network camera support log the system messages on remote server. The protocol is compliant to RFC 3164. If you have external Linux server with syslogd service, use “-r” option to turn on the facility for receiving log from remote machine. Or you can use some software on Windows which is compliant to RFC 3164.

Check “**Enable remote log**” and input the “**IP address**” and “**port**” number of the log server to enable the remote log facility.

In the “**Current log**”, it displays the current system log file. The content of the log provides useful information about configuration and connection after system boot- up.

The screenshot displays the web interface for the FCS-5030 IP Network Camera. The interface is divided into a left sidebar for navigation and a main content area. The sidebar includes sections for 'System Configuration' (Basic and Advanced) and 'Maintenance'. The 'Basic' section is expanded, showing options like Network, Video, Audio, System, and User Management. The 'Advanced' section includes Network, IP Filtering, Motion detection, Event Setup, Recording, Peripherals, System log, and Maintenance. The 'System log' option is selected in the sidebar.

The main content area is titled 'System log' and contains two sections:

- Remote Log:** This section allows for configuring remote logging. It includes a checkbox for 'Enable remote log', which is currently unchecked. Below it, there are input fields for 'Log server settings', 'IP address', and 'port'. The 'port' field is set to '514'. A 'Save' button is located at the bottom of this section.
- Current Log:** This section displays the current system log output. The log entries include:
 - Mar 6 14:34:26 syslogd 1.4.1: restart.
 - Mar 6 14:34:30 [DRM Service]: Starting DRM service.
 - Mar 6 14:34:41 [SYS]: Serial number = 0002D1067F00
 - Mar 6 14:34:41 [SYS]: System starts at Thu Mar 6 14:34:41 UTC 2008
 - Mar 6 14:34:41 [NET]: --- NET INFO ---
 - Mar 6 14:34:41 [NET]: Host IP = 192.168.10.248
 - Mar 6 14:34:41 [NET]: Subnet Mask = 255.255.255.0
 - Mar 6 14:34:41 [NET]: Gateway = 192.168.10.1
 - Mar 6 14:34:41 [NET]: Primary DNS = 168.95.1.1
 - Mar 6 14:34:41 [NET]: Secondary DNS = 192.168.10.4
 - Mar 6 14:34:42 [SYS]: Recording entry 0 stop
 - Mar 6 14:34:42 [SYS]: Recording entry 1 stop
 - Mar 6 14:34:42 [EVENT MGR]: reload config file
 - Mar 6 14:34:50 SYS: Sync with NTP server failed!
 - Mar 6 14:34:48 SYS: Sync with NTP server <2008/03/06 14:34:48>
 - Mar 6 15:34:07 SYS: Sync with NTP server failed!
 - Mar 6 15:34:08 SYS: Sync with NTP server <2008/03/06 15:34:08>
 - Mar 6 16:03:24 [RTSP SERVER]: Start one session, IP=192.168.10.140
 - Mar 6 16:29:12 [RTSP SERVER]: Start one session, IP=192.168.10.106
 - Mar 6 16:34:09 SYS: Sync with NTP server failed!

Maintenance

Five actions can be selected.

“Reboot system” Click the reboot button to restart system.

“Restore” Click it to restore all setting to factory default except setting in “Network type” in network page.

“Factory default” Click on Factory default button on the configuration page to restore the factory default settings. Any changes made so far will be lost and the system will be reset to the initial factory settings. The system will restart and require the installer program to set up the network again.

“Upgrade firmware” Select the firmware file and click upgrade button.

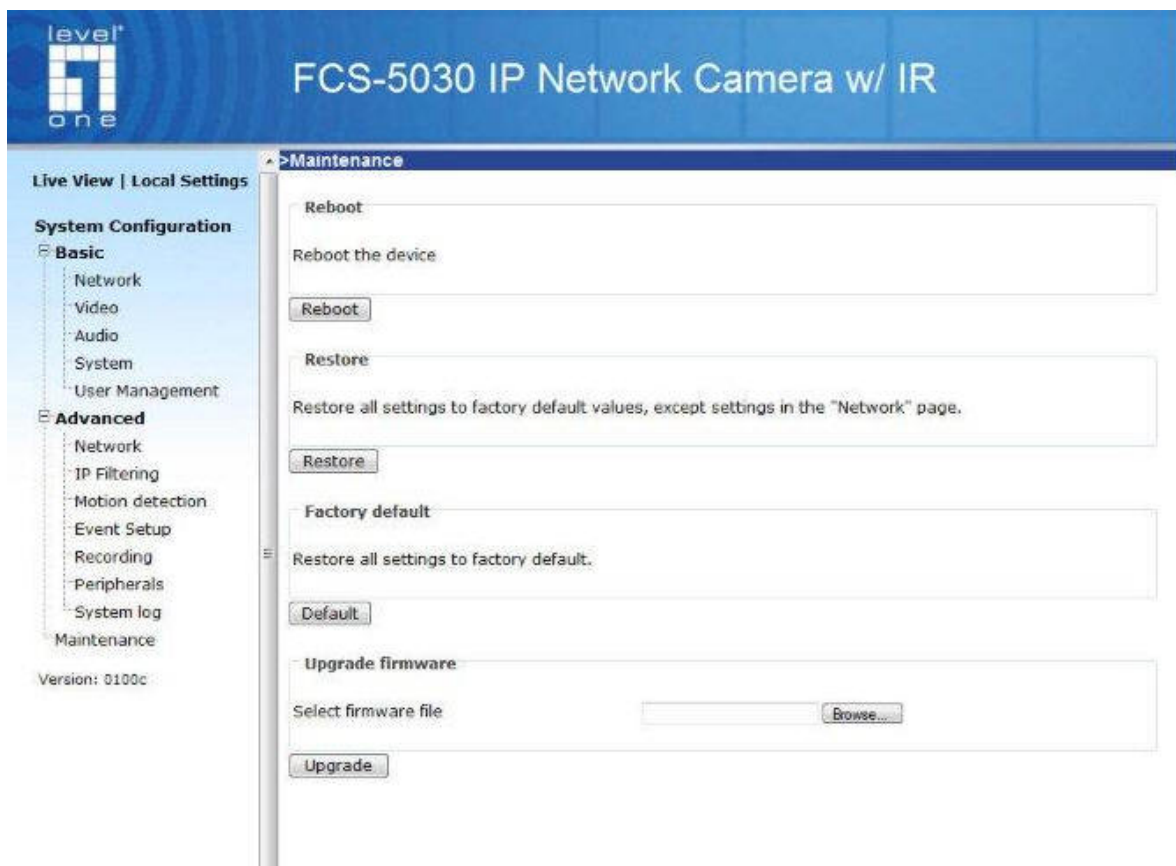

Appendix

A. Troubleshooting

Reset and restore

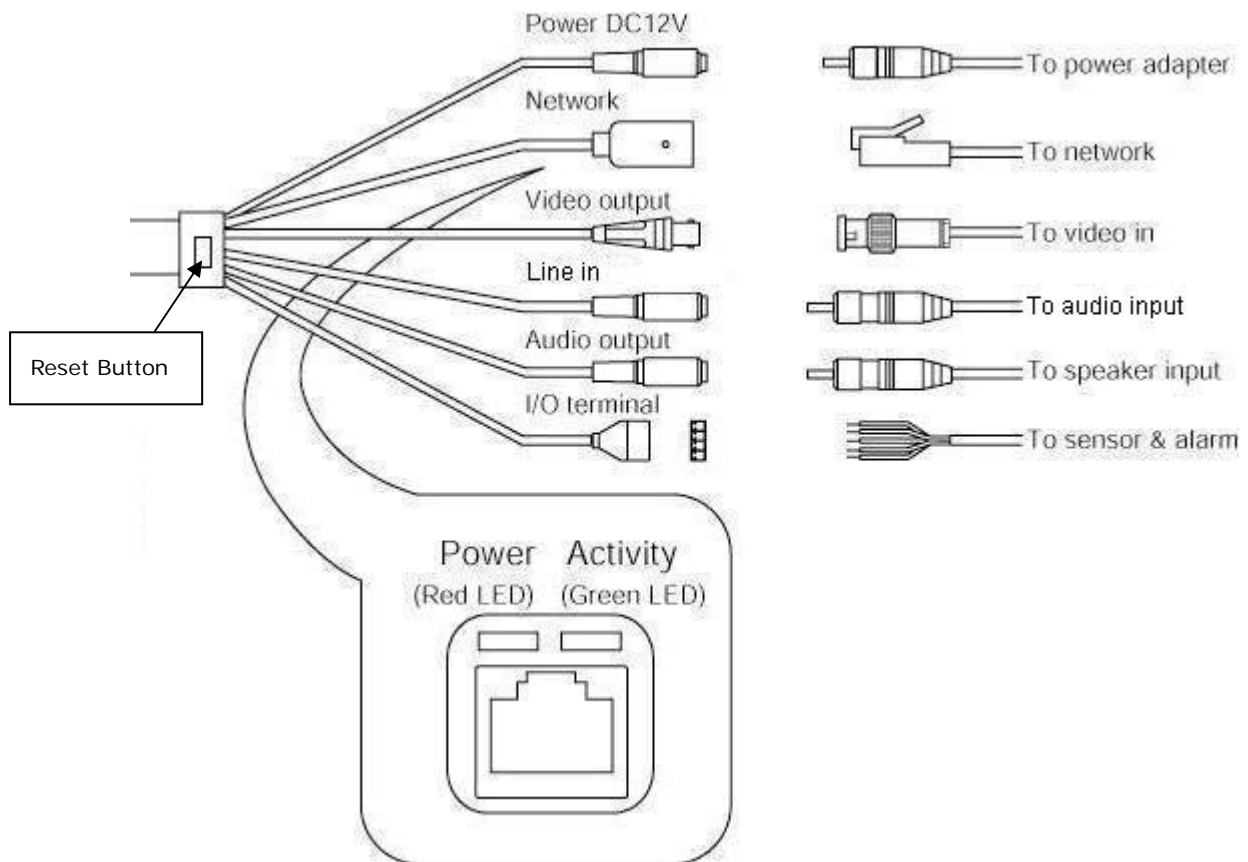

There is a button in the cable of the Network Camera. It is used to reset the system or restore the factory default settings. Sometimes resetting the system sets the system back to normal state. If the system problems remain after reset, restore the factory settings and install again.

RESET: Click on the button.

RESTORE: Press on the reset button continuously for **30 seconds**.



Restoring the factory defaults will erase any previous settings. Reset or restore the system after power on.

B. URL commands of the Network Camera

Overview

For some customers who already have their own web site or web control application, Network Camera/Video server can be easily integrated through convenient URLs. This section specifies the external HTTP based application programming interface. The HTTP based camera interface provides the functionality to request a single image, to control camera functions (PTZ, output relay etc.) and to get and set internal parameter values. The image and CGI-requests are handled by the built in Web server.

Style convention

In URL syntax and in descriptions of CGI parameters, a text within angle brackets denotes a content that is to be replaced with either a value or a string. When replacing the text string also the angle brackets shall be replaced. An example of this is the description of the name for the server, denoted with <servername> in the URL syntax description below, that is replaced with the string myserver in the URL syntax example, also below.

URL syntax' are written with the "**Syntax:**" word written in bold face followed by a box with the referred syntax as seen below. The name of the server is written as <servername>. This is intended to be replaced with the name of the actual server. This can either be a name, e.g., "mywebcam" or "thecam.adomain.net" or the associated IP number for the server, e.g., 192.168.0.220.

Syntax:

```
http://<servername>/cgi-bin/viewer/video.jpg
```

Description of returned data is written with "**Return:**" in bold face followed by the returned data in a box. All data returned as HTTP formatted, i.e., starting with the string HTTP is line separated with a Carriage Return and Line Feed (CRLF) printed as \r\n.

Return:

```
HTTP/1.0 <HTTP code> <HTTP text>\r\n
```

URL syntax examples are written with "**Example:**" in bold face followed by a short description and a light grey box with the example.

Example: request a single snapshot image

<http://mywebserver/cgi-bin/viewer/video.jpg>

General CGI URL syntax and parameters

CGI parameters are written in lower-case and as one word without any underscores or other separators. When the CGI request includes internal camera parameters, the internal parameters must be written exactly as they are named in the camera or video server. The CGIs are organized in function related directories under the cgi-bin directory. The file extension of the CGI is required.

Syntax:

```
http://<servername>/cgi-bin/<subdir>[/<subdir>...]/<cgi>.<ext>  
[?<parameter>=<value>[&<parameter>=<value>...]]
```

Example: Setting digital output #1 to active

<http://mywebserver/cgi-bin/dido/setdo.cgi?do1=1>

Security level

SECURITY LEVEL	SUB-DIRECTORY	DESCRIPTION
0	anonymous	Unprotected.
1 [view]	anonymous, viewer, dido, camctrl	1. Can view, listen, talk to camera 2. Can control dido, ptz of camera
4 [operator]	anonymous, viewer, dido, camctrl, operator	Operator's access right can modify most of camera's parameters except some privilege and network options
6 [admin]	anonymous, viewer, dido, camctrl, operator, admin	Administrator's access right can fully control the camera's operation.
7	N/A	Internal parameters. Unable to be changed by any external interface.

Get server parameter values

Note: The access right depends on the URL directory.

Method: GET/POST

Syntax:

```
http://<servername>/cgi-bin/anonymous/getparam.cgi? [<parameter>]
[&<parameter>...]

http://<servername>/cgi-bin/viewer/getparam.cgi? [<parameter>]
[&<parameter>...]

http://<servername>/cgi-bin/operator/getparam.cgi? [<parameter>]
[&<parameter>...]

http://<servername>/cgi-bin/admin/getparam.cgi? [<parameter>]
[&<parameter>...]
```

where the *<parameter>* should be *<group>[_<name>]* or *<group>[.<name>]* If you do not specify the any parameters, all the parameters on the server will be returned. If you specify only *<group>*, the parameters of related group will be returned.

When query parameter values, the current parameter value are returned.

Successful control request returns paramter pairs as follows.

Return:

```
HTTP/1.0 200 OK\r\n
Content-Type: text/html\r\n
Context-Length: <length>\r\n
\r\n
<parameter pair>
```

where *<parameter pair>* is

<parameter>=<value>\r\n

[<parameter pair>]

<length> is the actual length of content.

Example: request IP address and it's response

Request:

```
http://192.168.0.123/cgi-bin/admin/getparam.cgi?network_ipaddress
```

Response:

```

HTTP/1.0 200 OK\r\n
Content-Type: text/html\r\n
Context-Length: 33\r\n
\r\n
network.ipaddress=192.168.0.123\r\n

```

Set server parameter values

Note: The access right depends on the URL directory.

Method: GET/POST

Syntax:

```

http://<servername>/cgi-bin/<anonymous>/setparam.cgi? <parameter>=<value>
[&<parameter>=<value>...][&update=<value>][&return=<return page>]

http://<servername>/cgi-bin/<viewer>/setparam.cgi? <parameter>=<value>
[&<parameter>=<value>...][&update=<value>] [&return=<return page>]

http://<servername>/cgi-bin/<operator>/setparam.cgi? <parameter>=<value>
[&<parameter>=<value>...][&update=<value>] [&return=<return page>]

http://<servername>/cgi-bin/<admin>/setparam.cgi? <parameter>=<value>
[&<parameter>=<value>...][&update=<value>] [&return=<return page>]

```

PARAMETER	VALUE	DESCRIPTION
<group>_<name>	value to assigned	Assign <value> to the parameter <group>_<name>
update	<boolean>	set to 1 to actually update all fields (no need to use update parameter in each group)
return	<return page>	Redirect to the page <return page> after the parameter is assigned. The <return page> can be a full URL path or relative path according the the current path. If you omit this parameter, it will redirect to an empty page. (note: The return page can be a general HTML file(.htm, .html) or a LevelOne server script executable (.vspx) file. It can not be a CGI command. It can not have any extra parameters. This parameter must be put at end of

	parameter list)
--	-----------------

Return:

```
HTTP/1.0 200 OK\r\n
Content-Type: text/html\r\n
Context-Length: <length>\r\n
\r\n
<parameter pair>
```

where <parameter pair> is

<parameter>=<value>\r\n

[<parameter pair>]

Only the parameters that you set and readable will be returned.

Example: Set the IP address of server to 192.168.0.123

Request:

http://myserver/cgi-bin/admin/setparam.cgi?network_ipaddress=192.168.0.123

Response:

```
HTTP/1.0 200 OK\r\n
Content-Type: text/html\r\n
Context-Length: 33\r\n
\r\n
network.ipaddress=192.168.0.123\r\n
```

Available parameters on the server

Valid values:

VALID VALUES	DESCRIPTION
string[<n>]	Text string shorter than 'n' characters
password[<n>]	The same as string but display '*' instead
integer	Any number between $(-2^{31} - 1)$ and $(2^{31} - 1)$
positive integer	Any number between 0 and $(2^{32} - 1)$
<m> ~ <n>	Any number between 'm' and 'n'
domain name[<n>]	A string limited to contain a domain name shorter than 'n' characters (eg. www.ibm.com)

email address [<n>]	A string limited to contain a email address shorter than 'n' characters (eg. joe@www.ibm.com)
ip address	A string limited to contain an ip address (eg. 192.168.1.1)
mac address	A string limited to contain mac address without hyphen or colon connected
boolean	A boolean value 1 or 0 represents [Yes or No], [True or False], [Enable or Disable].
<value1>, <value2>, <value3>, ...	Enumeration. Only given values are valid.
blank	A blank string
everything inside <>	As description

NOTE: The camera should prevent to restart when parameter changed.

Group: **system**

NAME	VALUE	SECURITY (get/set)	DESCRIPTION
hostname	string[40]	1/6	host name of server
ledoff	<boolean>	6/6	turn on(0) or turn off(1) all led indicators
lowlight	<boolean>	6/6	(0) Turn on white light LED in all condition (1) Only turn on white light LED in low light condition
date	<yyyy/mm/dd>, keep, auto	6/6	Current date of system. Set to 'keep' keeping date unchanged. Set to 'auto' to use NTP to synchronize date.
time	<hh:mm:ss>, keep, auto	6/6	Current time of system. Set to 'keep' keeping time unchanged. Set to 'auto' to use NTP to synchronize time.
ntp	<domain name>, <ip address>, <blank>	6/6	NTP server
timezoneindex	-489 ~ 529	6/6	Indicate timezone and area

			<p>-480: GMT-12:00 Eniwetok, Kwajalein</p> <p>-440: GMT-11:00 Midway Island, Samoa</p> <p>-400: GMT-10:00 Hawaii</p> <p>-360: GMT-09:00 Alaska</p> <p>-320: GMT-08:00 Las Vegas, San_Francisco, Vancouver</p> <p>-280: GMT-07:00 Mountain Time, Denver</p> <p>-281: GMT-07:00 Arizona</p> <p>-240: GMT-06:00 Central America, Central Time, Mexico City, Saskatchewan</p> <p>-200: GMT-05:00 Eastern Time, New York, Toronto</p> <p>-201: GMT-05:00 Bogota, Lima, Quito, Indiana</p> <p>-160: GMT-04:00 Atlantic Time, Canada, Caracas, La Paz, Santiago</p> <p>-140: GMT-03:30 Newfoundland</p> <p>-120: GMT-03:00 Brasilia, Buenos Aires, Georgetown, Greenland</p> <p>-80: GMT-02:00 Mid-Atlantic</p> <p>-40: GMT-01:00 Azores, Cape_Verde_IS.</p> <p>0: GMT Casablanca, Greenwich Mean Time:Dublin, Edinburgh, Lisbon, London</p> <p>40: GMT 01:00 Amsterdam, Berlin, Rome, Stockholm, Vienna, Madrid, Paris</p> <p>41: GMT 01:00 Warsaw, Budapest, Bern</p> <p>80: GMT 02:00 Athens, Helsinki,</p>
--	--	--	---

		<p>Istanbul, Riga 81: GMT 02:00 Cairo 82: GMT 02:00 Lebanon, Minsk 83: GMT 02:00 Israel 120: GMT 03:00 Baghdad, Kuwait, Riyadh, Moscow, St. Petersburg, Nairobi 121: GMT 03:00 Iraq 140: GMT 03:30 Tehran 160: GMT 04:00 Abu Dhabi, Muscat, Baku, Tbilisi, Yerevan 180: GMT 04:30 Kabul 200: GMT 05:00 Ekaterinburg, Islamabad, Karachi, Tashkent 220: GMT 05:30 Calcutta, Chennai, Mumbai, New Delhi 230: GMT 05:45 Kathmandu 240: GMT 06:00 Almaty, Novosibirsk, Astana, Dhaka, Sri Jayawardenepura 260: GMT 06:30 Rangoon 280: GMT 07:00 Bangkok, Hanoi, Jakarta, Krasnoyarsk 320: GMT 08:00 Beijing, Chongqing, Hong Kong, Kuala Lumpur, Singapore, Taipei 360: GMT 09:00 Osaka, Sapporo, Tokyo, Seoul, Yakutsk 380: GMT 09:30 Adelaide, Darwin 400: GMT 10:00 Brisbane, Canberra, Melbourne, Sydney, Guam, Vladivostok 440: GMT 11:00 Magadan,</p>
--	--	---

			Solomon Is., New Caledonia 480: GMT 12:00 Auckland, Wellington, Fiji, Kamchatka, Marshall Is. 520: GMT 13:00 Nuku'Alofa
updateinterval	0, 3600, 86400, 604800, 2592000	6/6	0 to Disable automatic time adjustment, otherwise, it means the seconds between NTP automatic update interval.
restore	0, <positive integer>	7/6	Restore the system parameters to default value. Restart the server after <value> seconds.
reset	0, <positive integer>	7/6	Restart the server after <value> seconds.
restoreexceptnet	0, <positive integer>	7/6	Restore the system parameters to default value except (ipaddress, subnet, router, dns1, dns2, ddns settings). Restart the server after <value> seconds.

SubGroup of **system: info** (The fields in this group are unchangeable.)

NAME	VALUE	SECURITY (get/set)	DESCRIPTION
modelname	string[40]	0/7	model name of server
serialnumber	<mac address>	0/7	12 characters mac address without hyphen connected
firmwareversion	string[40]	0/7	The version of firmware, including model, company, and version number in the format <MODEL-BRAND-VERSION>
language_default	string[16]	0/7	Default webpage language.
language_count	<integer>	0/7	number of webpage language available on the server
language_i<0~(count-1)>	string[16]	0/7	Available language lists

Group: **status**

NAME	VALUE	SECURITY (get/set)	DESCRIPTION
di_i<0~(ndi-1)>	<boolean>	1/7	0 => Inactive, normal 1 => Active, triggered
do_i<0~ndi-1)>	<boolean>	1/1	0 => Inactive, normal 1 => Active, triggered
onlinenum_rtsp	integer	6/7	current RTSP connection numbers
onlinenum_httppush	integer	6/7	current HTTP push server connection numbers

Group: **di_i<0~(ndi-1)>**

NAME	VALUE	SECURITY (get/set)	DESCRIPTION
normalstate	high, low	1/1	indicate whether open circuit or closed circuit represents inactive status

Group: **do_i<0~(ndo-1)>**

NAME	VALUE	SECURITY (get/set)	DESCRIPTION
normalstate	open, grounded	1/1	indicate whether open circuit or closed circuit represents inactive status

Group: **security**

NAME	VALUE	SECURITY (get/set)	DESCRIPTION
user_i0_name	string[64]	6/7	User's name of root
user_i<1~20>_name	string[64]	6/7	User's name
user_i0_pass	string [64]	6/6	Root's password
user_i<1~20>_pass	string [64]	7/6	User's password
user_i0_privilege	admin	6/7	Root's privilege
user_i<1~20>_ privilege	viewer, operator,	6/6	User's privilege.

	admin		
--	-------	--	--

Group: **network**

NAME	VALUE	SECURITY (get/set)	DESCRIPTION
type	lan, pppoe	6/6	Network connection type
resetip	<boolean>	6/6	1 => get ipaddress, subnet, router, dns1, dns2 from DHCP server at next reboot 0 => use preset ipaddress, subnet, router, dns1, and dns2
ipaddress	<ip address>	6/6	IP address of server
subnet	<ip address>	6/6	subnet mask
router	<ip address>	6/6	default gateway
dns1	<ip address>	6/6	primary DNS server
dns2	<ip address>	6/6	secondary DNS server
wins1	<ip address>	6/6	primary WINS server
wins2	<ip address>	6/6	secondary WINS server

Subgroup of **network**: **ftp**

NAME	VALUE	SECURITY (get/set)	DESCRIPTION
port	21, 1025~65535	6/6	local ftp server port

Subgroup of **network**: **http**

NAME	VALUE	SECURITY (get/set)	DESCRIPTION
port	80, 1025 ~ 65535	6/6	HTTP port
alternateport	1025~65535	6/6	Alternative HTTP port
authmode	basic, digest	1/6	HTTP authentication mode
s0_accessname	string[32]	1/6	Http server push access name for stream 1
s1_accessname	string[32]	1/6	Http server push access name for stream 2

Subgroup of **network: rtsp**

NAME	VALUE	SECURITY (get/set)	DESCRIPTION
port	554, 1025 ~ 65535	6/6	RTSP port
authmode	disable, basic, digest	1/6	RTSP authentication mode
s0_accessname	string[32]	1/6	RTSP access name for stream1
s1_accessname	string[32]	1/6	RTSP access name for stream2

Subgroup of **rtsp_s<0~(n-1)>: multicast**, n is stream count

NAME	VALUE	SECURITY (get/set)	DESCRIPTION
alwaysmulticast	<boolean>	4/4	Enable always multicast
ipaddress	<ip address>	4/4	Multicast IP address
videoport	1025 ~ 65535	4/4	Multicast video port
audioport	1025 ~ 65535	4/4	Multicast audio port
ttl	1 ~ 255	4/4	Multicast time to live value

Subgroup of **network: rtp**

NAME	VALUE	SECURITY (get/set)	DESCRIPTION
videoport	1025 ~ 65535	6/6	video channel port for RTP
audioport	1025 ~ 65535	6/6	audio channel port for RTP

Subgroup of **network: pppoe**

NAME	VALUE	SECURITY (get/set)	DESCRIPTION
user	string[128]	6/6	PPPoE account user name
pass	password[64]	6/6	PPPoE account password

Group: ipfilter

NAME	VALUE	SECURITY (get/set)	DESCRIPTION
------	-------	-----------------------	-------------

allow_i<0~9>_start	1.0.0.0 ~ 255.255.255.25 5	6/6	Allowed starting IP address for RTSP connection
allow_i<0~9>_end	1.0.0.0 ~ 255.255.255.25 5	6/6	Allowed ending IP address for RTSP connection
deny_i<0~9>_start	1.0.0.0 ~ 255.255.255.25 5	6/6	Denied starting IP address for RTSP connection
deny_i<0~9>_end	1.0.0.0 ~ 255.255.255.25 5	6/6	Denied ending IP address for RTSP connection

Group: **videoin**

NAME	VALUE	SECURITY (get/set)	DESCRIPTION
cmosfreq	50, 60	4/4	CMOS frequency
whitebalance	auto, indoor, fluorescent, outdoor	4/4	auto, auto white balance indoor, 3200K fluorescent, 5500K outdoor, > 5500K

Group: **videoin_c<0~(n-1)>** for n channel products, m is stream number

NAME	VALUE	SECURITY (get/set)	DESCRIPTION
color	0, 1	4/4	0 => monochrome 1 => color
flip	<boolean>	4/4	flip the image
mirror	<boolean>	4/4	mirror the image
ptzstatus	<integer>	1/7	An 32-bits integer, each bit can be set separately as follows: Bit 0 => Support camera control function 0(not support), 1(support) Bit 1 => Build-in or external camera. 0(external), 1(build-in) Bit 2 => Support pan operation. 0(not support), 1(support) Bit 3 => Support tilt operation.

			0(not support), 1(support) Bit 4 => Support zoom operation. 0(not support), 1(support) Bit 5 => Support focus operation. 0(not support), 1(support)
text	string[16]	1/4	enclosed caption
imprinttimestamp	<boolean>	4/4	Overlay time stamp on video
maxexposure	1~120	4/4	Maximum exposure time
s<0~(m-1)>_codectyp e	mpeg4, mjpeg	4/4	video codec type
s<0~(m-1)>_keyinterv al	1, 3, 5, 10, 30, 60, 90, 120	4/4	Key frame interval
s<0~(m-1)>_resolution	176x144, 320x240, 640x480, 800x600, 1280x1024	4/4	Video resolution in pixel
s<0~(m-1)>_ratecontr olmode	cbr, vbr	4/4	cbr, constant bitrate vbr, fix quality
s<0~(m-1)>_quant	1, 2, 3, 4, 5	4/4	quality of video when choosing vbr in "ratecontrolmode". 1 is worst quality and 5 is the best quality.
s<0~(m-1)>_bitrate	20000, 30000, 40000, 50000, 64000, 128000, 256000, 384000, 512000, 768000, 1000000, 1200000, 1500000, 2000000, 3000000,	4/4	set bit rate in bps when choose cbr in "ratecontrolmode"

	4000000		
s<0~(m-1)>_maxframe	1, 2, 3, 5, 10, 15, 20, 25, 30 (only for NTSC or 60Hz CMOS)	4/4	set maximum frame rate in fps
s<0~(m-1)>_forcei	1	7/6	Force I frame

Group: **audioin_c<0~(n-1)>** for n channel products

NAME	VALUE	SECURITY (get/set)	DESCRIPTION
mute	0, 1	4/4	Enable audio mute
gain	0~31	4/4	Gain of input
boostmic	0, 1	4/4	Enable microphone boost
s<0~(m-1)>_codectype	aac4, gamr	4/4	set audio codec type for input
s<0~(m-1)>_aac4_bitrate	16000, 32000, 48000, 64000, 96000, 128000	4/4	set AAC4 bitrate in bps
s<0~(m-1)>_gamr_bitrate	4750, 5150, 5900, 6700, 7400, 7950, 10200, 12200	4/4	set AMR bitrate in bps

Group: **image_c<0~(n-1)>** for n channel products

NAME	VALUE	SECURITY (get/set)	DESCRIPTION
brightness	-5 ~ 5	4/4	Adjust brightness of image according to mode settings.
saturation	-5 ~ 5	4/4	Adjust saturation of image according to mode settings.

contrast	-5 ~ 5	4/4	Adjust contrast of image according to mode settings.
hue	-5 ~ 5	4/4	Adjust hue of image according to mode settings.

Group: **motion_c<0~(n-1)>** for n channel product

NAME	VALUE	SECURITY (get/set)	DESCRIPTION
enable	<boolean>	4/4	enable motion detection
win_i<0~2>_enable	<boolean>	4/4	enable motion window 1~3
win_i <0~2>_name	string[14]	4/4	name of motion window 1~3
win_i <0~2>_left	0 ~ 320	4/4	Left coordinate of window position.
win_i <0~2>_top	0 ~ 240	4/4	Top coordinate of window position.
win_i <0~2>_width	0 ~ 320	4/4	Width of motion detection window.
win_i<0~2>_height	0 ~ 240	4/4	Height of motion detection window.
win_i<0~2>_objsize	0 ~ 100	4/4	Percent of motion detection window.
win_i<0~2>_sensitivity	0 ~ 100	4/4	Sensitivity of motion detection window.

Group: **ddns**

NAME	VALUE	SECURITY (get/set)	DESCRIPTION
enable	<boolean>	6/6	Enable or disable the dynamic dns.
provider	Safe100, DyndnsDynamic, DyndnsCustom, TZO, DHS, DynInterfree, PeanutHull, CustomSafe100	6/6	Safe100 => safe100.net DyndnsDynamic => dyndns.org (dynamic) DyndnsCustom => dyndns.org (custom) TZO => tzo.com DHS => dhs.org DynInterfree => dyn-interfree.it PeanutHull => peanut hull CustomSafe100 => Custom server using safe100 method
<provider>_hostna	string[128]	6/6	Your dynamic hostname.

me			
<provider>_usernameemail	string[64]	6/6	Your user or email to login ddns service provider
<provider>_passwordkey	string[64]	6/6	Your password or key to login ddns service provider
<provider>_servername	string[128]	6/6	The server name for safe100. (This field only exists for provider is customsaf100)

Group: upnpresentation

NAME	VALUE	SECURITY (get/set)	DESCRIPTION
enable	<boolean>	6/6	Enable or disable the UPNP presentation service.

Group: upnpportforwarding

NAME	VALUE	SECURITY (get/set)	DESCRIPTION
enable	<boolean>	6/6	Enable or disable the UPNP port forwarding service.
upnpnatstatus	0~3	6/7	The status of UpnP port forwarding, used internally. 0 is OK, 1 is FAIL, 2 is no IGD router, 3 is no need to do port forwarding

Group: **syslog**

NAME	VALUE	SECURITY (get/set)	DESCRIPTION
enableremotelog	<boolean>	6/6	enable remote log
serverip	<IP address>	6/6	Log server IP address
serverport	514, 1025~65535	6/6	Server port used for log
level	0~7	6/6	The levels to distinguish the importance of information. 0: LOG_EMERG 1: LOG_ALERT 2: LOG_CRIT

			3: LOG_ERR 4: LOG_WARNING 5: LOG_NOTICE 6: LOG_INFO 7: LOG_DEBUG
--	--	--	--

Group: **privacymask_c<0~(n-1)>** for n channel product

NAME	VALUE	SECURITY (get/set)	DESCRIPTION
enable	<boolean>	4/4	Enable the privacy mask
win_j<0~4>_enable	<boolean>	4/4	Enable the privacy mask window
win_j<0~4>_name	string[14]	4/4	The name of privacy mask window
win_j<0~4>_left	0 ~ 320/352	4/4	Left coordinate of window position.
win_j<0~4>_top	0 ~ 240/288	4/4	Top coordinate of window position.
win_j<0~4>_width	0 ~ 320/352	4/4	Width of privacy mask window
win_j<0~4>_height	0 ~ 240/288	4/4	Height of privacy mask window

Group: capability

NAME	VALUE	SECURITY (get/set)	DESCRIPTION
api_http_version	0200a	0/7	The HTTP API version.
bootuptime	<positive integer>	0/7	The server bootup time
nir	0, <positive integer>	0/7	number of IR interface
ndi	0, <positive integer>	0/7	number of digital input
ndo	0, <positive integer>	0/7	number of digital output
naudioin	0, <positive integer>	0/7	number of audio input

naudioout	0, <positive integer>	0/7	number of audio output
nvideoin	<positive integer>	0/7	number of video input
nmediastream	<positive integer>	0/7	number of media stream per channel
nvideosetting	<positive integer>	0/7	number of video settings per channel
naudiosetting	<positive integer>	0/7	number of audio settings per channel
nuart	0, <positive integer>	0/7	number of UART interface
ptzenabled	< boolean >	0/7	indicate whether to support PTZ control
protocol_https	< boolean >	0/7	indicate whether to support http over SSL
protocol_rtsp	< boolean >	0/7	indicate whether to support rtsp
protocol_sip	<boolean>	0/7	indicate whether to support sip
protocol_maxconnection	<positive integer>	0/7	The maximum allowed simultaneous connections
protocol_rtp_multicast_ scalable	<boolean>	0/7	indicate whether to support scalable multicast
protocol_rtp_multicast_ backchannel	<boolean>	0/7	indicate whether to support backchannel multicast
protocol_rtp_tcp	<boolean>	0/7	indicate whether to support rtp over tcp
protocol_rtp_http	<boolean>	0/7	indicate whether to support rtp over http
protocol_spush_mjpeg	<boolean>	0/7	indicate whether to support server push motion jpeg
protocol_snmp	<boolean>	0/7	indicate whether to support snmp
videoin_type	0, 1, 2	0/7	0 => Interlaced CCD 1 => Progressive CCD 2 => CMOS
videoin_resolution	<a list of the	0/7	available resolutions list

	available resolution separates by comma)		
videoin_codec	<a list of the available codec types separators by comma)	0/7	available codec list
videoout_codec	<a list of the available codec types separators by comma)	0/7	available codec list
audio_aec	<boolean>	0/7	indicate whether to support acoustic echo cancellation
audio_extmic	<boolean>	0/7	indicate whether to support external microphone input
audio_linein	<boolean>	0/7	indicate whether to support external line input
audio_lineout	<boolean>	0/7	indicate whether to support line output
audio_headphoneout	<boolean>	0/7	indicate whether to support headphone output
audioin_codec	<a list of the available codec types separators by comma)	0/7	available codec list
audioout_codec	<a list of the available codec types separators by comma)	0/7	available codec list
camctrl_httpstunnel	<boolean>	0/7	Indicate whether to support the http tunnel for camera control
uart_httpstunnel	<boolean>	0/7	Indicate whether to support the http tunnel for uart transfer

transmission_mode	Tx, Rx, Both	0/7	Indicate what kind of transmission mode the machine used. TX: server, Rx: receiver box, Both: DVR?.
network_wire	<boolean>	0/7	Indicate whether to support the Ethernet
network_wireless	<boolean>	0/7	Indicate whether to support the wireless
wireless_802dot11b	<boolean>	0/7	Indicate whether to support the wireless 802.11b+
wireless_802dot11g	<boolean>	0/7	Indicate whether to support the wireless 802.11g
wireless_encrypt_wep	<boolean>	0/7	Indicate whether to support the wireless WEP
wireless_encrypt_wpa	<boolean>	0/7	Indicate whether to support the wireless WPA
wireless_encrypt_wpa2	<boolean>	0/7	Indicate whether to support the wireless WPA2

Group: event_i<0~2>

PARAMETER	VALUE	SECURITY (get/set)	DESCRIPTION
name	string[40]	6/6	The identification of this entry
enable	0, 1	6/6	To enable or disable this event.
priority	0, 1, 2	6/6	Indicate the priority of this event. "0" indicates low priority. "1" indicates normal priority. "2" indicates high priority.
delay	1~999	6/6	Delay seconds before detect next event.
trigger	boot, di, motion, seq,	6/6	Indicate the trigger condition. "boot" indicates system boot. "di" indicates digital input. "motion" indicates video motion detection. "seq" indicates periodic condition.

di	<integer>	6/6	Indicate which di detected. This field is required when trigger condition is "di". One bit represents one digital input. The LSB indicates DI 0.
mdwin	<integer>	6/6	Indicate which motion detection windows detected. This field is required when trigger condition is "md". One bit represents one window. The LSB indicates the 1 st window. For example, to detect the 1 st and 3 rd windows, set mdwin as 5.
inter	1~999	6/6	Interval of period snapshot in minute. This field is used when trigger condition is "seq".
weekday	<interger>	6/6	Indicate which weekday is scheduled. One bit represents one weekday. The bit0 (LSB) indicates Saturday. The bit1 indicates Friday. The bit2 indicates Thursday. The bit3 indicates Wednesday. The bit4 indicates Tuesday. The bit5 indicates Monday. The bit6 indicates Sunday. For example, to detect events on Friday and Sunday, set weekday as 66.
begintime	hh:mm	6/6	Begin time of weekly schedule.
endtime	hh:mm	6/6	End time of weekly schedule. (00:00 ~ 24:00 means always.)
action_do_i<0~(ndo-1)>_enable	0, 1	6/6	To enable or disable trigger digital output.
action_do_i<0~(ndo-1)>_duration	1~999	6/6	The duration of digital output is triggered in seconds.
action_server_i<0~4>_enable	0, 1	6/6	To enable or disable this server action. The default value is 0.
action_server_i<0~4>_media	NULL, 0~4	6/6	The index of attached media.

Group: server_i<0~4>

PARAMETER	VALUE	SECURITY (get/set)	DESCRIPTION
name	string[40]	6/6	The identification of this entry
type	email, ftp, http, ns	6/6	Indicate the server type. “email” is email server. “ftp” is ftp server. “http” is http server. “ns” is network storage.
http_url	string[128]	6/6	The url of http server to upload.
http_username	string[64]	6/6	The username to login in the server.
http_passwd	string[64]	6/6	The password of the user.
ftp_address	string[128]	6/6	The ftp server address
ftp_username	string[64]	6/6	The username to login in the server.
ftp_passwd	string[64]	6/6	The password of the user.
ftp_port	0~65535	6/6	The port to connect the server.
ftp_location	string[128]	6/6	The location to upload or store the media.
ftp_passive	0, 1	6/6	To enable or disable the passive mode. 0 is to disable the passive mode. 1 is to enable the passive mode.
email_address	string[128]	6/6	The email server address
email_username	string[64]	6/6	The username to login in the server.
email_passwd	string[64]	6/6	The password of the user.
email_senderemail	string[128]	6/6	The email address of sender.
email_recipientemail	string[128]	6/6	The email address of recipient.
ns_location	string[128]	6/6	The location to upload or store the media.
ns_username	string[64]	6/6	The username to login in the server.
ns_passwd	string[64]	6/6	The password of the user.
ns_workgroup	string[64]	6/6	The workgroup for network storage.

Group: media_i<0~4>

PARAMETER	VALUE	SECURITY (get/set)	DESCRIPTION
-----------	-------	-----------------------	-------------

name	string[40]	6/6	The identification of this entry
type	snapshot, systemlog videoclip	6/6	The media type to send to the server or store by the server.
snapshot_source	<integer>	6/6	Indicate the source of media stream. 0 means the first stream. 1 means the second stream and etc.
snapshot_prefix	string[16]	6/6	Indicate the prefix of the filename.
snapshot_datesuffix	0, 1	6/6	To add date and time suffix to filename or not. 1 means to add date and time suffix. 0 means not to add it.
snapshot_preevent	0 ~ 7	6/6	It indicates the number of pre-event images.
snapshot_postevent	0 ~ 7	6/6	The number of post-event images.
videoclip_source	<integer>	6/6	Indicate the source of media stream. 0 means the first stream. 1 means the second stream and etc.
videoclip_prefix	string[16]	6/6	Indicate the prefix of the filename.
videoclip_preevent	0 ~ 9	6/6	It indicates the time of pre-event recording in seconds.
videoclip_maxduration	1 ~ 10	6/6	The time of maximum duration of one video clip in seconds.
videoclip_maxsize	50 ~ 1500	6/6	The maximum size of one video clip file in Kbytes.

Group: record_i<0~1>

PARAMETER	VALUE	SECURITY (get/set)	DESCRIPTION
name	string[40]	6/6	The identification of this entry
enable	0, 1	6/6	To enable or disable this recoding.
priority	0, 1, 2	6/6	Indicate the priority of this recoding. “0” indicates low priority. “1” indicates normal priority. “2” indicates high priority.

source	<integer>	6/6	Indicate the source of media stream. 0 means the first stream. 1 means the second stream and etc.
weekday	<interger>	6/6	Indicate which weekday is scheduled. One bit represents one weekday. The bit0 (LSB) indicates Saturday. The bit1 indicates Friday. The bit2 indicates Thursday. The bit3 indicates Wednesday. The bit4 indicates Tuesday. The bit5 indicates Monday. The bit6 indicates Sunday. For example, to detect events on Friday and Sunday, set weekday as 66.
begintime	hh:mm	6/6	Begin time of weekly schedule.
endtime	hh:mm	6/6	End time of weekly schedule. (00:00~24:00 means always.)
prefix	string[16]	6/6	Indicate the prefix of the filename.
cyclesize	<integer>	6/6	The maximum size for cycle recording in Kbytes.
maxfilesize	200~6000	6/6	The max size for one file in Kbytes
dest	0~4	6/6	The destination to store the recording data. "0~4" means the index of network storage.

Drive the digital output

Note: This request requires the privilege of viewer.

Method: GET/POST

Syntax:

```
http://<servername>/cgi-bin/dido/setdo.cgi?do1=<state>[&do2=<state>]
[&do3=<state>][&do4=<state>][&return=<return page>]
```

Where state is 0, 1. "0" means inactive or normal state while "1" means active or triggered state.

PARAMETER	VALUE	DESCRIPTION
-----------	-------	-------------

do<num>	0, 1	0 – inactive, normal state
		1 – active, triggered state
return	<return page>	Redirect to the page <return page> after the parameter is assigned. The <return page> can be a full URL path or relative path according the the current path. If you omit this parameter, it will redirect to an empty page.

Example: Drive the digital output 1 to triggered state and redirect to an empty page

<http://myserver/cgi-bin/dido/setdo.cgi?do1=1>

Query status of the digital input

Note: This request requires the privilege of viewer.

Method: GET/POST

Syntax:

`http://<servername>/cgi-bin/dido/getdi.cgi?[di0][&di1][&di2][&di3]`

If no parameter is specified, all the status of digital input will be returned.

Return:

```
HTTP/1.0 200 OK\r\n
Content-Type: text/plain\r\n
Content-Length: <length>\r\n
\r\n
[di0=<state>]\r\n
[di1=<state>]\r\n
[di2=<state>]\r\n
[di3=<state>]\r\n
```

where <state> can be 0 or 1.

Example: Query the status of digital input 1

Request:

<http://myserver/cgi-bin/dido/getdi.cgi?di1>

```
Response:
HTTP/1.0 200 OK\r\n
Content-Type: text/plain\r\n
Content-Length: 7\r\n
\r\n
di1=1\r\n
```

Query status of the digital output

Note: This request requires the privilege of viewer.

Method: GET/POST

Syntax:

```
http://<servername>/cgi-bin/dido/getdo.cgi?[do0][&do1][&do2][&do3]
```

If no parameter is specified, all the status of digital output will be returned.

Return:

```
HTTP/1.0 200 OK\r\n
Content-Type: text/plain\r\n
Content-Length: <length>\r\n
\r\n
[do0=<state>]\r\n
[do1=<state>]\r\n
[do2=<state>]\r\n
[do3=<state>]\r\n
```

where <state> can be 0 or 1.

Example: Query the status of digital output 1

```
Request:
http://myserver/cgi-bin/dido/getdo.cgi?do1
```

```
Response:
HTTP/1.0 200 OK\r\n
Content-Type: text/plain\r\n
Content-Length: 7\r\n
\r\n
```

```
do1=1\r\n
```

Capture single snapshot

Note: This request require normal user privilege

Method: GET/POST

Syntax:

```
http://<servername>/cgi-bin/viewer/video.jpg?[channel=<value>][&resolution=<value>]  
[&quality=<value>]
```

If the user requests the size larger than all stream setting on the server, this request will failed!

PARAMETER	VALUE	DEFAULT	DESCRIPTION
channel	0~(n-1)	0	the channel number of video source
resolution	<available resolution>	0	The resolution of image
quality	1~5	3	The quality of image

Server will return the most up-to-date snapshot of selected channel and stream in JPEG format.

The size and quality of image will be set according to the video settings on the server.

Return:

```
HTTP/1.0 200 OK\r\n  
Content-Type: image/jpeg\r\n  
[Content-Length: <image size>\r\n]  
  
<binary JPEG image data>
```

Account management

Note: This request requires administrator privilege

Method: GET/POST

Syntax:

<http://<servername>/cgi-bin/admin/editaccount.cgi?>

method=<value>&username=<name>[&userpass=<value>][&privilege=<value>]

[&privilege=<value>][...][&return=<return page>]

PARAMETER	VALUE	DESCRIPTION
method	add	Add an account to server. When using this method, "username" field is necessary. It will use default value of other fields if not specified.
	delete	Remove an account from server. When using this method, "username" field is necessary, and others are ignored.
	edit	Modify the account password and privilege. When using this method, "username" field is necessary, and other fields are optional. If not specified, it will keep original settings.
username	<name>	The name of user to add, delete or edit
userpass	<value>	The password of new user to add or that of old user to modify. The default value is an empty string.
privilege	<value>	The privilege of user to add or to modify.
	viewer	viewer's privilege
	operator	operator's privilege
	admin	administrator's privilege
return	<return page>	Redirect to the page <return page> after the parameter is assigned. The <return page> can be a full URL path or relative path according the the current path. If you omit this parameter, it will redirect to an empty page.

System logs

Note: This request require administrator privilege

Method: GET/POST

Syntax:

<http://<servername>/cgi-bin/admin/syslog.cgi>

Server will return the up-to-date system log.

Return:

```
HTTP/1.0 200 OK\r\n
Content-Type: text/plain\r\n
Content-Length: <syslog length>\r\n
\r\n
<system log information>\r\n
```

Upgrade firmware

Note: This request requires administrator privilege

Method: POST

Syntax:

```
http://<servername>/cgi-bin/admin/upgrade.cgi
```

Post data:

```
fimage=<file name>[&return=<return page>]\r\n
\r\n
<multipart encoded form data>
```

Server will accept the upload file named <file name> to be upgraded the firmware and return with <return page> if indicated.

IP filtering

Note: This request requires administrator access privilege

Method: GET/POST

Syntax:

```
http://<servername>/cgi-bin/admin/ipfilter.cgi?
method=<value>&[start=<ipaddress>&end=<ipaddress>][&index=<value>]
[&return=<return page>]
```

PARAMETER	VALUE	DESCRIPTION
Method	addallow	Add a set of allow IP address range to server. Start and end parameters must be specified. If the index parameter is specified, it will try to add starting from index position.
	adddeny	Add a set of deny IP address range to server. Start and end parameters must be specified. If the index parameter is specified, it will try to add starting from index position.
	deleteallow	Remove a set of allow IP address range from server. If start and end parameters are specified, it will try to remove the matched IP address. If index is specified, it will try to remove the address from given index position. [start, end] parameters have higher priority than the [index] parameter.
	deletedeny	Remove a set of deny IP address range from server. If start and end parameters are specified, it will try to remove the matched IP address. If index is specified, it will try to remove the address from given index position. [start, end] parameters have higher priority than the [index] parameter.
start	<ip address>	The start IP address to add or to delete.
end	<ip address>	The end IP address to add or to delete.
index	<value>	The start position to add or to delete.
return	<return page>	Redirect to the page <return page> after the parameter is assigned. The <return page> can be a full URL path or relative path according to the current path. If you omit this parameter, it will redirect to an empty page.

RTSP SDP

Note: This request requires viewer access privilege

Method: GET/POST

Syntax:

```
http://<servername>/viewer/<0~(n-1)>/<network_accessname_<0~(m-1)>>
```

```
rtsp://<servername>/<0~(n-1)>/<network_accessname_<0~(m-1)>>
```

“n” is the channel number and “m” is the stream number.

You can get the SDP by HTTP or just describe by RTSP protocol directly. For detailed streaming protocol, please refer to “control signaling” and “data format” documents.

D. Specifications

- System

RAM: 64MB SDRAM
ROM: 8MB FLASH ROM

- Networking

Protocol

TCP/IP, HTTP, SMTP, FTP, DDNS, UPnP, Telnet, NTP, DNS, DHCP and RTSP

Physical

10 baseT or 100 baseT Fast Ethernet auto negotiation

- Video

Algorithm supported

MPEG4(simple profile) for streaming video
JPEG for still image

Features

Adjustable image size, quality and bit rate
Time stamp and text overlay
3 motion detection windows

Resolution

704x480 pixels(NTSC)
704x576 pixels(PAL)

- Camera Specification

1/3 inch colour CCD
176x120: 30/25fps
352x240: 30/25fps
704x480: 30/25fps
0Lux/F2.0 when IR on

- Lens

8mm, F2.0

-IR LEDs

12 crystal IR LEDs for night view up to 30 meters

- Audio

AAC, GSM-AMR

- Dimension

158mm(L) x 105mm(W) x 108mm(H)

- Weight

NET. 1010g

- Power

12V/1.5A

- Operating Environment

Temperature: 0-50°C/32-122°F
Humidity: 95%RH

- EMI & Safety

CE, FCC

- Viewing system requirement

Operating system

Microsoft Windows 2000/XP/VISTA

Browser

Internet Explorer 6.x or above

Firefox 1.5.0.x or above

Technology License Notice

MPEG-4 AAC Technology

THIS PRODUCT IS LICENSED UNDER THE MPEG-4 AAC AUDIO PATENT LICENSE. THIS PRODUCT MAY NOT BE DECOMPILED, REVERSE-ENGINEERED OR COPIED, EXCEPT REGARD TO PC SOFTWARE, YOU MAY MAKE SINGLE COPIES FOR ARCHIVAL PURPOSES. FOR MORE INFORMATION, PLEASE REFER TO [HTTP://WWW.VIALICENSING.COM](http://www.vialicensing.com).

MPEG-4 Visual Technology

THIS PRODUCT IS LICENSED UNDER THE MPEG-4 VISUAL PATENT PORTFOLIO LICENSE FOR THE PERSONAL AND NON-COMMERCIAL USE OF A CONSUMER FOR (i) ENCODING VIDEO IN COMPLIANCE WITH THE MPEG-4 VISUAL STANDARD ("MPEG-4 VIDEO") AND/OR (ii) DECODING MPEG-4 VIDEO THAT WAS ENCODED BY A CONSUMER ENGAGED IN A PERSONAL AND NON-COMMERCIAL ACTIVITY AND/OR WAS OBTAINED FROM A VIDEO PROVIDER LICENSED BY MPEG LA TO PROVIDE MPEG-4 VIDEO. NO LICENSE IS GRANTED OR SHALL BE IMPLIED FOR ANY OTHER USE. ADDITIONAL INFORMATION INCLUDING THAT RELATING TO PROMOTIONAL, INTERNAL AND COMMERCIAL USES AND LICENSING MAY BE OBTAINED FROM MPEG LA, LLC. SEE [HTTP://WWW.MPEGLA.COM](http://www.mpegla.com).

AMR-NB Standard

THIS PRODUCT IS LICENSED UNDER THE AMR-NB STANDARD PATENT LICENSE AGREEMENT. WITH RESPECT TO THE USE OF THIS PRODUCT, THE FOLLOWING LICENSORS' PATENTS MAY APPLY:

TELEFONAKIEBOLAGET ERICSSON AB: US PAT. 6192335; 6275798; 6029125; 6424938; 6058359. NOKIA CORPORATION: US PAT. 5946651; 6199035. VOICEAGE CORPORATION: AT PAT. 0516621; BE PAT. 0516621; CA PAT. 2010830; CH PAT. 0516621; DE PAT. 0516621; DK PAT. 0516621; ES PAT. 0516621; FR PAT. 0516621; GB PAT. 0516621; GR PAT. 0516621; IT PAT. 0516621; LI PAT. 0516621; LU PAT. 0516621; NL PAT. 0516621; SE PAT 0516621; US PAT 5444816; AT PAT. 819303/AT E 198805T1; AU PAT. 697256; BE PAT. 819303; BR PAT. 9604838-7; CA PAT. 2216315; CH PAT. 819303; CN PAT. ZL96193827.7; DE PAT. 819303/DE69611607T2; DK PAT. 819303; ES PAT. 819303; EP PAT. 819303; FR PAT. 819303; GB PAT. 819303; IT PAT. 819303; JP PAT. APP. 8-529817; NL PAT. 819303; SE PAT. 819303; US PAT. 5664053. THE LIST MAY BE UPDATED FROM TIME TO

TIME BY LICENSORS AND A CURRENT VERSION OF WHICH IS AVAILABLE ON
LICENSOR'S WEBSITE AT [HTTP://WWW.VOICEAGE.COM](http://www.voiceage.com).

Electromagnetic Compatibility (EMC)

This device complies with FCC Rules Part 15. Operation is subject to the following two conditions.

- This device may not cause harmful interference, and
- This device must accept any interference received, including interference that may cause undesired operation.

USA - This equipment has been tested and found to comply with the limits for a Class B digital device, pursuant to Part 15 of the FCC Rules. These limits are designed to provide reasonable protection against harmful interference in a residential installation. This equipment generates, uses and can radiate radio frequency energy and, if not installed and used in accordance with the instructions, may cause harmful interference to radio communications. However, there is no guarantee that interference will not occur in a partial installation. If this equipment does cause harmful interference to radio or television reception, which can be determined by turning the equipment off and on, the user is encouraged to try to correct the interference by one or more of the following measures:

- Reorient or relocate the receiving antenna.
- Increase the separation between the equipment and receiver.
- Connect the equipment into an outlet on a circuit different from that to which the receiver is connected.
- Consult the dealer or an experienced radio/TV technician for help.

Shielded interface cables must be used in order to comply with emission limits.

Europe  - This digital equipment fulfills the requirement for radiated emission according to limit B of EN55022/1998, and the requirement for immunity according to EN50082-1/1992.

Liability

LevelOne Inc. cannot be held responsible for any technical or typographical errors and reserves the right to make changes to the product and manuals without prior notice. LevelOne Inc. makes no warranty of any kind with regard to the material contained within this document, including, but not limited to, the implied warranties of merchantability and fitness for any particular purpose.

GNU GENERAL PUBLIC LICENSE

Version 2, June 1991

Copyright (C) 1989, 1991 Free Software Foundation, Inc.

59 Temple Place, Suite 330, Boston, MA 02111-1307 USA

Everyone is permitted to copy and distribute verbatim copies of this license document, but changing it is not allowed.

Preamble

The licenses for most software are designed to take away your freedom to share and change it. By contrast, the GNU General Public License is intended to guarantee your freedom to share and change free software--to make sure the software is free for all its users. This General Public License applies to most of the Free Software Foundation's software and to any other program whose authors commit to using it. (Some other Free Software Foundation software is covered by the GNU Library General Public License instead.) You can apply it to your programs, too.

When we speak of free software, we are referring to freedom, not price. Our General Public Licenses are designed to make sure that you have the freedom to distribute copies of free software (and charge for this service if you wish), that you receive source code or can get it if you want it, that you can change the software or use pieces of it in new free programs; and that you know you can do these things.

To protect your rights, we need to make restrictions that forbid anyone to deny you these rights or to ask you to surrender the rights. These restrictions translate to certain responsibilities for you if you distribute copies of the software, or if you modify it.

For example, if you distribute copies of such a program, whether gratis or for a fee, you must give the recipients all the rights that you have. You must make sure that they, too, receive or can get the source code. And you must show them these terms so they know their rights.

We protect your rights with two steps: (1) copyright the software, and (2) offer you this license which gives you legal permission to copy, distribute and/or modify the software.

Also, for each author's protection and ours, we want to make certain that everyone understands that there is no warranty for this free software. If the software is modified by someone else and passed on, we want its recipients to know that what they have is not the original, so that any problems introduced by others will not reflect on the original authors' reputations.

Finally, any free program is threatened constantly by software patents. We wish to avoid the danger that redistributors of a free program will individually obtain patent licenses, in effect

making the program proprietary. To prevent this, we have made it clear that any patent must be licensed for everyone's free use or not licensed at all. The precise terms and conditions for copying, distribution and modification follow.

GNU GENERAL PUBLIC LICENSE

Terms And Conditions For Copying, Distribution And Modification

0. This License applies to any program or other work which contains a notice placed by the copyright holder saying it may be distributed under the terms of this General Public License. The "Program", below, refers to any such program or work, and a "work based on the Program" means either the Program or any derivative work under copyright law: that is to say, a work containing the Program or a portion of it, either verbatim or with modifications and/or translated into another language. (Hereinafter, translation is included without limitation in the term "modification".) Each licensee is addressed as "you".

Activities other than copying, distribution and modification are not covered by this License; they are outside its scope. The act of running the Program is not restricted, and the output from the Program is covered only if its contents constitute a work based on the Program (independent of having been made by running the Program). Whether that is true depends on what the Program does.

1. You may copy and distribute verbatim copies of the Program's source code as you receive it, in any medium, provided that you conspicuously and appropriately publish on each copy an appropriate copyright notice and disclaimer of warranty; keep intact all the notices that refer to this License and to the absence of any warranty; and give any other recipients of the Program a copy of this License along with the Program.

You may charge a fee for the physical act of transferring a copy, and you may at your option offer warranty protection in exchange for a fee.

2. You may modify your copy or copies of the Program or any portion of it, thus forming a work based on the Program, and copy and distribute such modifications or work under the terms of Section 1 above, provided that you also meet all of these conditions:

- a) You must cause the modified files to carry prominent notices stating that you changed the files and the date of any change.
- b) You must cause any work that you distribute or publish, that in whole or in part contains or is derived from the Program or any part thereof, to be licensed as a whole at no charge to all third parties under the terms of this License.
- c) If the modified program normally reads commands interactively when run, you must cause it, when started running for such interactive use in the most ordinary way, to print or display an

announcement including an appropriate copyright notice and a notice that there is no warranty (or else, saying that you provide a warranty) and that users may redistribute the program under these conditions, and telling the user how to view a copy of this License. (Exception: if the Program itself is interactive but does not normally print such an announcement, your work based on the Program is not required to print an announcement.)

These requirements apply to the modified work as a whole. If identifiable sections of that work are not derived from the Program, and can be reasonably considered independent and separate works in themselves, then this License, and its terms, do not apply to those sections when you distribute them as separate works. But when you distribute the same sections as part of a whole which is a work based on the Program, the distribution of the whole must be on the terms of this License, whose permissions for other licensees extend to the entire whole, and thus to each and every part regardless of who wrote it. Thus, it is not the intent of this section to claim rights or contest your rights to work written entirely by you; rather, the intent is to exercise the right to control the distribution of derivative or collective works based on the Program.

In addition, mere aggregation of another work not based on the Program with the Program (or with a work based on the Program) on a volume of a storage or distribution medium does not bring the other work under the scope of this License.

3. You may copy and distribute the Program (or a work based on it, under Section 2) in object code or executable form under the terms of Sections 1 and 2 above provided that you also do one of the following:

a) Accompany it with the complete corresponding machine-readable source code, which must be distributed under the terms of Sections 1 and 2 above on a medium customarily used for software interchange; or,

b) Accompany it with a written offer, valid for at least three years, to give any third party, for a charge no more than your cost of physically performing source distribution, a complete machine-readable copy of the corresponding source code, to be distributed under the terms of Sections 1 and 2 above on a medium customarily used for software interchange; or,

c) Accompany it with the information you received as to the offer to distribute corresponding source code. (This alternative is allowed only for noncommercial distribution and only if you received the program in object code or executable form with such an offer, in accord with Subsection b above.)

The source code for a work means the preferred form of the work for making modifications to it. For an executable work, complete source code means all the source code for all modules it contains, plus any associated interface definition files, plus the scripts used to control compilation and installation of the executable. However, as a special exception, the source code distributed need not include anything that is normally distributed (in either source or

binary form) with the major components (compiler, kernel, and so on) of the operating system on which the executable runs, unless that component itself accompanies the executable.

If distribution of executable or object code is made by offering access to copy from a designated place, then offering equivalent access to copy the source code from the same place counts as distribution of the source code, even though third parties are not compelled to copy the source along with the object code.

4. You may not copy, modify, sublicense, or distribute the Program except as expressly provided under this License. Any attempt otherwise to copy, modify, sublicense or distribute the Program is void, and will automatically terminate your rights under this License. However, parties who have received copies, or rights, from you under this License will not have their licenses terminated so long as such parties remain in full compliance.

5. You are not required to accept this License, since you have not signed it. However, nothing else grants you permission to modify or distribute the Program or its derivative works. These actions are prohibited by law if you do not accept this License. Therefore, by modifying or distributing the Program (or any work based on the Program), you indicate your acceptance of this License to do so, and all its terms and conditions for copying, distributing or modifying the Program or works based on it.

6. Each time you redistribute the Program (or any work based on the Program), the recipient automatically receives a license from the original licensor to copy, distribute or modify the Program subject to these terms and conditions. You may not impose any further restrictions on the recipients' exercise of the rights granted herein. You are not responsible for enforcing compliance by third parties to this License.

7. If, as a consequence of a court judgment or allegation of patent infringement or for any other reason (not limited to patent issues), conditions are imposed on you (whether by court order, agreement or otherwise) that contradict the conditions of this License, they do not excuse you from the conditions of this License. If you cannot distribute so as to satisfy simultaneously your obligations under this License and any other pertinent obligations, then as a consequence you may not distribute the Program at all. For example, if a patent license would not permit royalty-free redistribution of the Program by all those who receive copies directly or indirectly through you, then the only way you could satisfy both it and this License would be to refrain entirely from distribution of the Program.

If any portion of this section is held invalid or unenforceable under any particular circumstance, the balance of the section is intended to apply and the section as a whole is intended to apply in other circumstances.

It is not the purpose of this section to induce you to infringe any patents or other property right claims or to contest validity of any such claims; this section has the sole purpose of protecting the integrity of the free software distribution system, which is implemented by public license

practices. Many people have made generous contributions to the wide range of software distributed through that system in reliance on consistent application of that system; it is up to the author/donor to decide if he or she is willing to distribute software through any other system and a licensee cannot impose that choice.

This section is intended to make thoroughly clear what is believed to be a consequence of the rest of this License.

8. If the distribution and/or use of the Program is restricted in certain countries either by patents or by copyrighted interfaces, the original copyright holder who places the Program under this License may add an explicit geographical distribution limitation excluding those countries, so that distribution is permitted only in or among countries not thus excluded. In such case, this License incorporates the limitation as if written in the body of this License.

9. The Free Software Foundation may publish revised and/or new versions of the General Public License from time to time. Such new versions will be similar in spirit to the present version, but may differ in detail to address new problems or concerns.

Each version is given a distinguishing version number. If the Program specifies a version number of this License which applies to it and "any later version", you have the option of following the terms and conditions either of that version or of any later version published by the Free Software Foundation. If the Program does not specify a version number of this License, you may choose any version ever published by the Free Software Foundation.

10. If you wish to incorporate parts of the Program into other free programs whose distribution conditions are different, write to the author to ask for permission. For software which is copyrighted by the Free Software Foundation, write to the Free Software Foundation; we sometimes make exceptions for this. Our decision will be guided by the two goals of preserving the free status of all derivatives of our free software and of promoting the sharing and reuse of software generally.

NO WARRANTY

11. BECAUSE THE PROGRAM IS LICENSED FREE OF CHARGE, THERE IS NO WARRANTY FOR THE PROGRAM, TO THE EXTENT PERMITTED BY APPLICABLE LAW. EXCEPT WHEN OTHERWISE STATED IN WRITING THE COPYRIGHT HOLDERS AND/OR OTHER PARTIES

PROVIDE THE PROGRAM "AS IS" WITHOUT WARRANTY OF ANY KIND, EITHER EXPRESSED OR IMPLIED, INCLUDING, BUT NOT LIMITED TO, THE IMPLIED WARRANTIES OF MERCHANTABILITY AND FITNESS FOR A PARTICULAR PURPOSE. THE ENTIRE RISK AS TO THE QUALITY AND PERFORMANCE OF THE PROGRAM IS WITH YOU. SHOULD THE PROGRAM PROVE DEFECTIVE, YOU ASSUME THE COST OF ALL NECESSARY SERVICING,

REPAIR OR CORRECTION.

12. IN NO EVENT UNLESS REQUIRED BY APPLICABLE LAW OR AGREED TO IN WRITING WILL ANY COPYRIGHT HOLDER, OR ANY OTHER PARTY WHO MAY MODIFY AND/OR REDISTRIBUTE THE PROGRAM AS PERMITTED ABOVE, BE LIABLE TO YOU FOR DAMAGES, INCLUDING ANY GENERAL, SPECIAL, INCIDENTAL OR CONSEQUENTIAL DAMAGES ARISING OUT OF THE USE OR INABILITY TO USE THE PROGRAM (INCLUDING BUT NOT LIMITED TO LOSS OF DATA OR DATA BEING RENDERED INACCURATE OR LOSSES SUSTAINED BY YOU OR THIRD PARTIES OR A FAILURE OF THE PROGRAM TO OPERATE WITH ANY OTHER PROGRAMS), EVEN IF SUCH HOLDER OR OTHER PARTY HAS BEEN ADVISED OF THE POSSIBILITY OF SUCH DAMAGES.

This product incorporates open source code into the software and therefore falls under the guidelines governed by the General Public License (GPL) agreement.

Adhering to the GPL requirements, the open source code and open source license for the source code are available for free download at <http://global.level1.com>.

If you would like a copy of the GPL or other open source code in this software on a physical CD medium, LevelOne (Digital Data Communications) offers to mail this CD to you upon request, for a price of US\$9.99 plus the cost of shipping.

